

ZAPPING SERVIÇOS FCCN

20 de outubro de 2021

Patrocinadores Platina



Patrocinadores Ouro

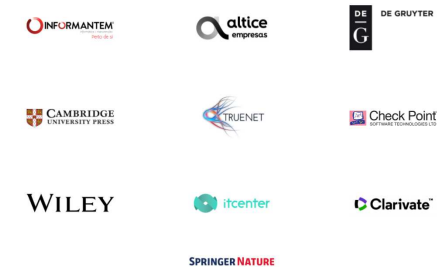

Patrocinadores Prata



Apoios



BIBLIOTECA DO CONHECIMENTO ONLINE (B-ON)

Zapping

Joana Novais



[F31D-B2C8-4F69](#)



[0000-0002-1244-9636](#)

Patrocinadores Platina



Patrocinadores Ouro

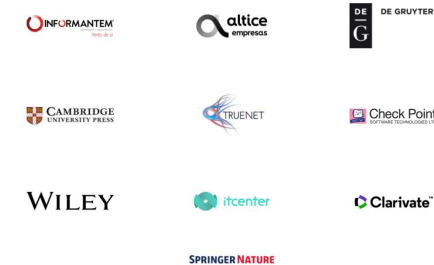

Patrocinadores Prata



Apoios



A B-ON

Conteúdos Científicos

Missão:

Assegurar o acesso a conteúdos científicos de elevada qualidade e prestígio.

Serviços Eletrónicos

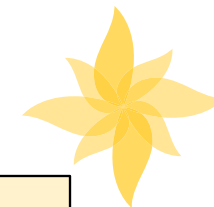

Publicação
Acesso Aberto



biblioteca do conhecimento online



Comunicação e Formação

2021: A B-ON CONTINUA A CRESCER

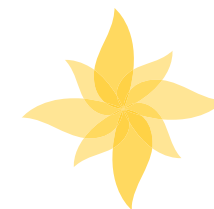

63
instituições
+2
membros
em 2021



+31%
downloads
(Proj. 2021)



+42%
Artigos
publicados com
condições b-on
(Proj. 2021)

2021: UM ANO DE MUDANÇA

Fevereiro 2021: Adesão da FCT ao Plano S

- Implementação para todo o financiamento a partir de **1/1/2022**

O Plano S:

- **Nenhum** artigo financiado deverá ficar **fechado**
- O **acesso aberto** deve ser **imediate**
- O autor/instituição deve **reter o copyright**

Próximos passos e desafios:

- Atualização da Política de Acesso Aberto FCT
- Comunicação e Esclarecimentos

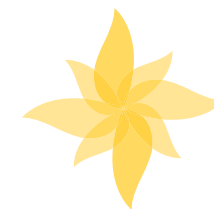

2021: UM ANO DE NEGOCIAÇÕES

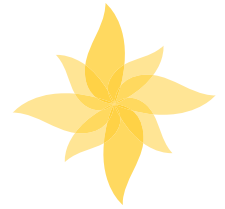

Maio 2021: Arranque das negociações do próximo ciclo b-on (2022-2024)

2 objetivos claros:

- Contenção de custos
- Conversão para Acordos Transformativos

Desafio principal:

- Output científico b-on muito elevado!

Próximos passos:

- Finalizar os acordos ainda em negociação
- Processos aquisitivos

Resultado Global:*

Cobertura do output b-on



60%
em 2024

* Algumas negociações ainda em curso.

2022: UMA B-ON MAIS MODERNIZADA

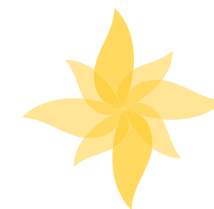

Novos acordos transformativos



10*

Acordos
Transformativos



>3250

artigos
Incluídos em 2022

* Algumas negociações ainda em curso.

2022: UMA B-ON MAIS PROFISSIONAL

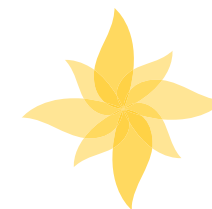

Nova ferramenta de gestão: Consortia Manager

The screenshot displays the Consortia Manager interface. At the top, there is a navigation bar with 'OVERVIEW', 'LIST VIEWS', 'MORE', a search bar, and 'SETTINGS'. Below this, the 'OVERVIEW' section shows a 'Task overview' with a 'Task overview' button and 'All contacts'. A horizontal bar contains five main sections: 'NEGOTIATE', 'TITLE LIST', 'PUBLISH', 'PUBLISHER ORDERS', and 'LIBRARY INVO'. Under 'NEGOTIATE', there are two cards: 'Start renewals' with a value of 16 and 'Forecast prices' with a value of 3. Below these is a 'Renewals per agreement & member' section with a legend for 'Accepted' (blue), 'Waiting' (grey), 'Not sent' (black), and 'Rejected' (dark blue). A dropdown menu is open, showing 'Agreements (22)', 'My agreements (22)', and 'Members (64)'. The main table lists agreements with columns for 'Agreement', 'Auto renew', 'Deadline', and 'Renewal progress'. The table contains three rows of data.

Agreement	Auto renew	Deadline	Renewal progress
ACM b-on 2022	Disabled	31 Dec 2022	58
ACS b-on 2021	Disabled	31 Dec 2021	42
AIP b-on 2021	Disabled	31 Dec 2021	57

VENHA SABER COMO FOI E COMO VAI SER!

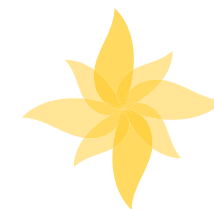

Sessões da b-on: quinta-feira 21/10

9h30: O ano de 2021 para a b-on

- Balanço de 2020/2021
- Adesão da FCT ao Plano S
- *Rights Retention Strategy* – o que é?



11h30: Novidades b-on para 2022

- Novos Acordos b-on 2022-2024
- Nova ferramenta “Consortia Manager”
- “Some for Some” 2022-2024

Obrigada!

Jornadas Computação Científica 2021



CIÊNCIA ID

JOÃO GUERREIRO

Patrocinadores Platina



Patrocinadores Ouro

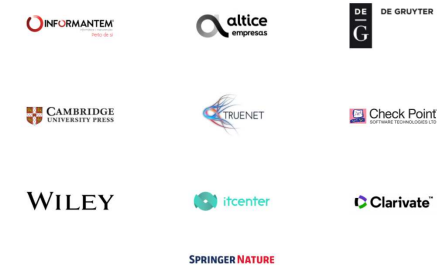

Patrocinadores Prata



Apoios



i> CIÊNCIA ID – O QUE É?

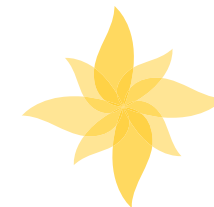

1 www.ciencia-id.pt

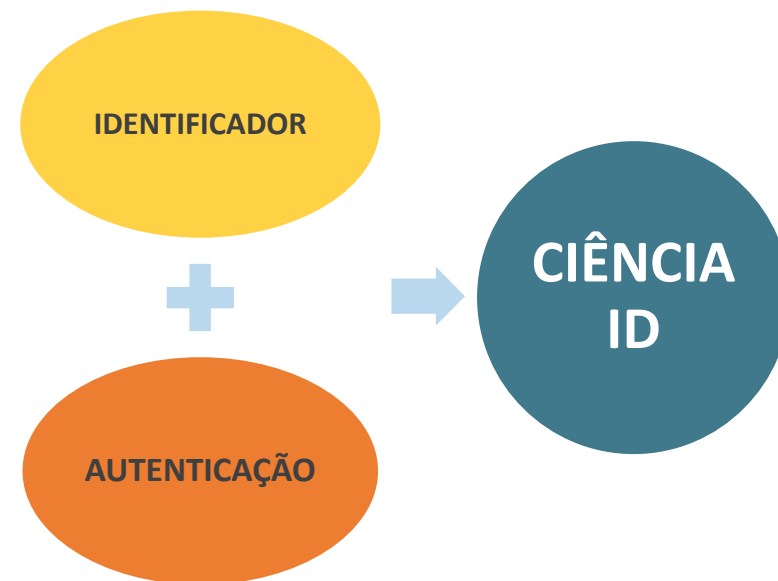

i→ CIÊNCIA ID – O QUE É?

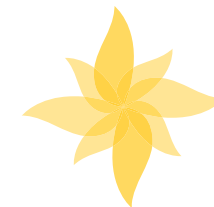

2 Registar CIÊNCIA ID

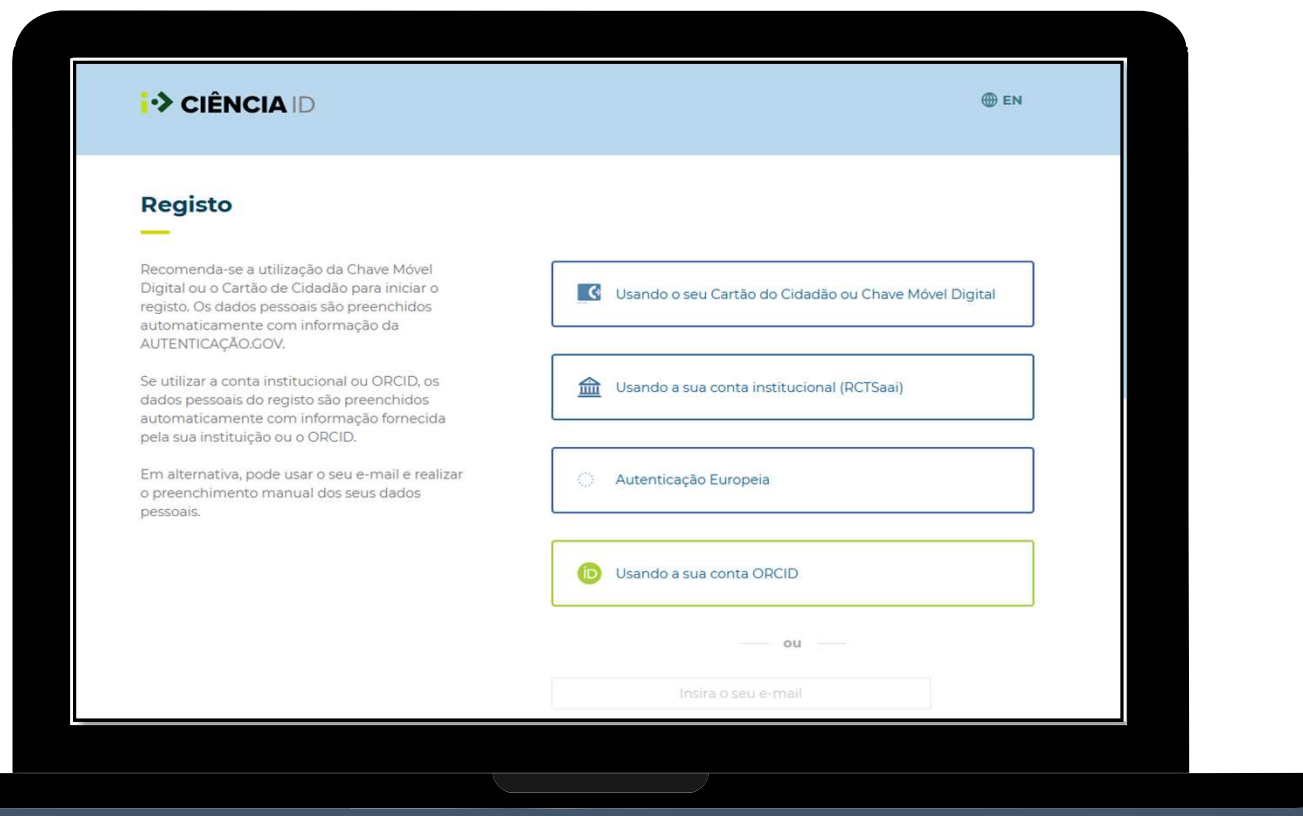

i→ CIÊNCIA ID – O QUE É?

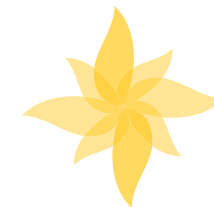

3 Aceder a Serviços

myFCT gestão de financiamento

Bem-vindo! O myFCT é o novo sistema online para gerir todo o ciclo de vida do financiamento concedido pela FCT.

O myFCT foi concebido para suportar o processo de candidatura, avaliação, aprovação e gestão de financiamento num único sistema.

Concursos

Nome	Tipo de Concurso	Data de Início	Data de Fim	Estado
Concurso de Projetos de Computação Avançada (2ª edição)	Projetos de Computação Avançada	19.07.2021 - 12:00	13.09.2021 - 12:00	Fechado
Acordo de Cooperação Científica entre Portugal e a Alemanha	Bilateral	16.06.2021 - 08:00	10.09.2021 - 17:00	Fechado

Entrar com i→ CIÊNCIA ID

i→ CIÊNCIA ID – O QUE É?

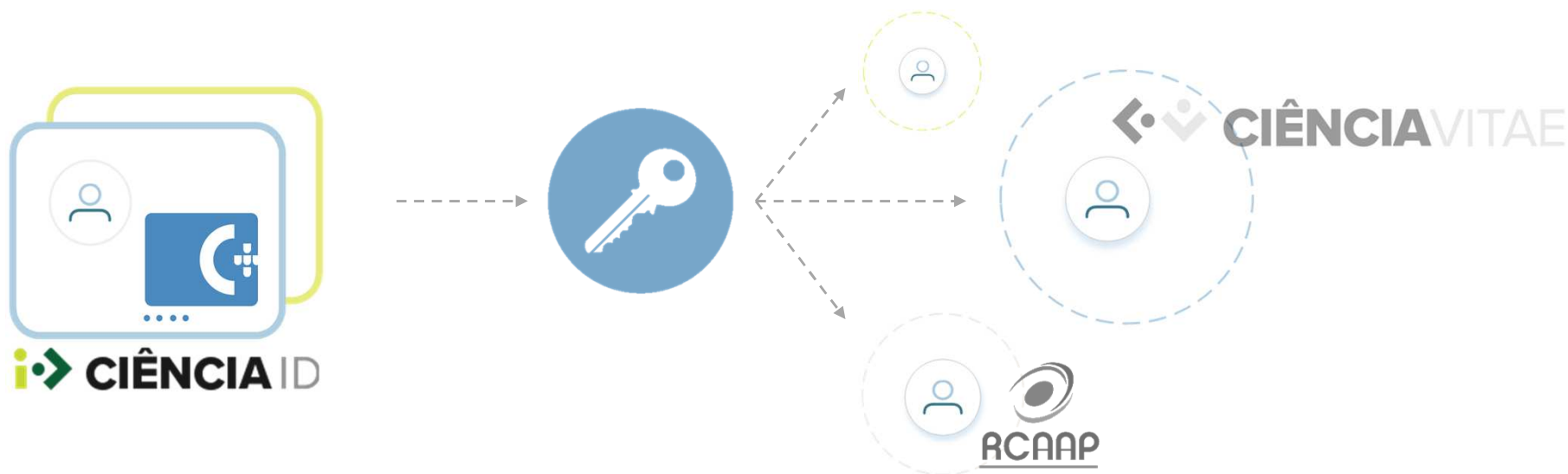
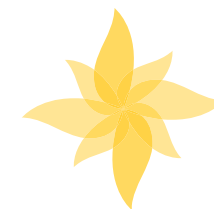

Uma única conta para acesso aos vários serviços de ciência

i> CIÊNCIA ID – QUE SERVIÇOS POSSO USAR?



Repositórios



CIÊNCIA VITAE

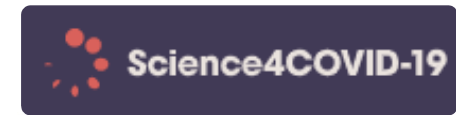

myFCT gestão de financiamento

FCT SIG

Projetos de Investigação Científica
Calls for R&D Projects

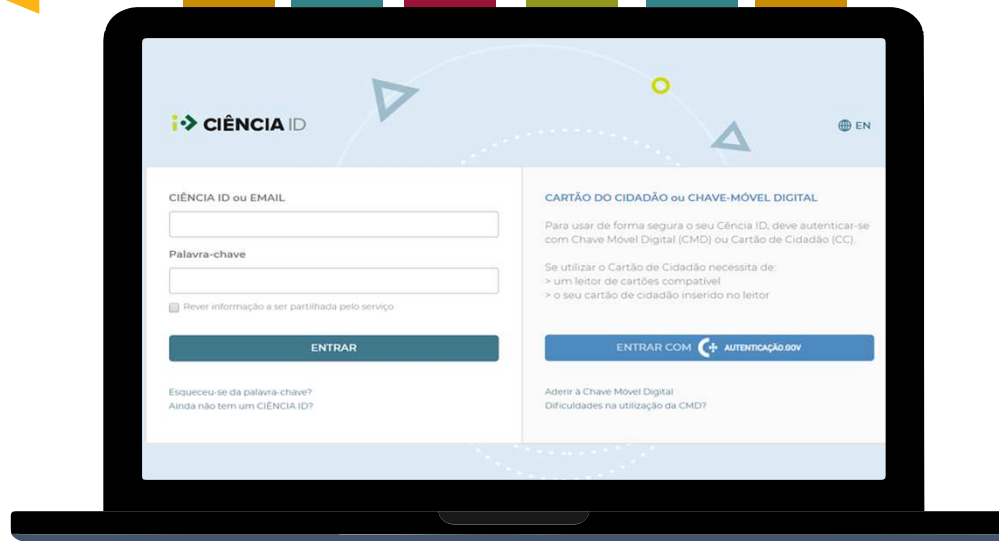



jornadas.fcn.pt

i> CIÊNCIA ID – NOVAS FUNCIONALIDADES



 Usando o seu Cartão do Cidadão ou Chave Móvel Digital

 Usando a sua conta institucional (RCTSaai) 

 Autenticação Europeia

 Usando a sua conta ORCID 

— ou —

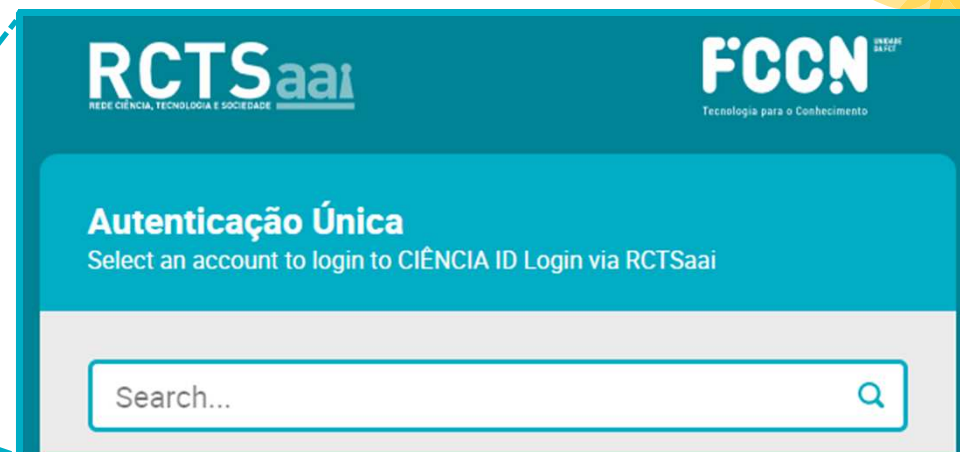

RCTSaai
REDE CIÊNCIA, TECNOLOGIA E SOCIEDADE

FCCN
Tecnologia para o Conhecimento

Autenticação Única

Select an account to login to CIÊNCIA ID Login via RCTSaai



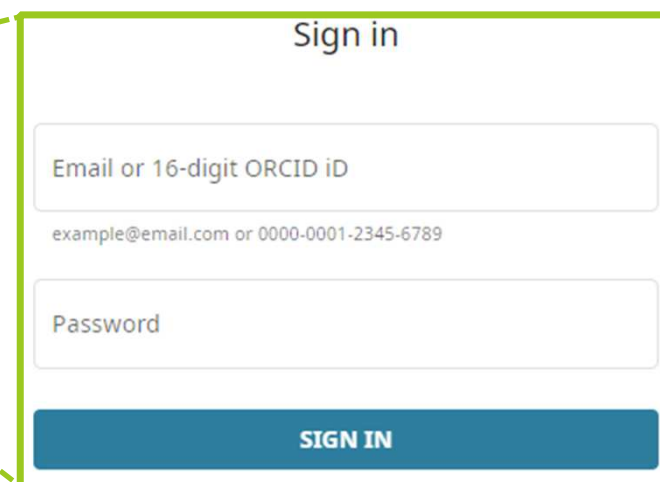



Sign in

example@email.com or 0000-0001-2345-6789

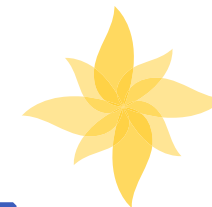

SIGN IN

i→ CIÊNCIA ID – NOVAS FUNCIONALIDADES



 Usando o seu Cartão do Cidadão ou Chave Móvel Digital

 Usando a sua conta institucional (RCTSaai)

 Autenticação Europeia 

 Usando a sua conta ORCID

— ou —

Insira o seu e-mail

eIDAS

Fundação para a Ciência e a Tecnologia solicitou alguns dos seus dados para realizar o serviço online pretendido ⓘ

Apelido(s)

Data de nascimento



Identificador único

Nome



Selecione o país

 DE

 VOLTAR **AUTORIZAR** 

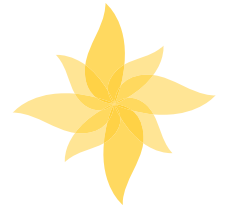

Utilizadores Registados: >17.000 (Total: >82.000)

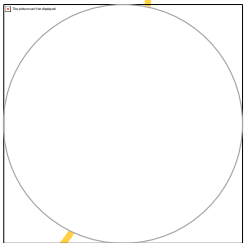

Autenticações: >660.000 (>2.400 por dia)

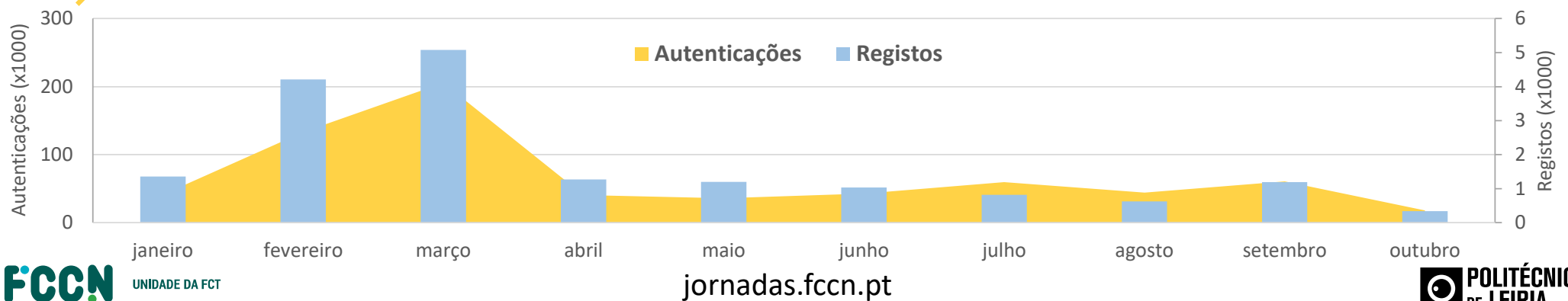

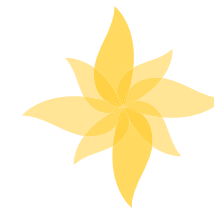

Assegurar a evolução e qualidade do serviço

Desenvolvimentos

- Autenticação via **eduGAIN**
- Disponibilizar informação no perfil CIÊNCIA ID de **serviços já visitados**



Integrações

- Integração de novos serviços



RCTSai – Sistema de Autenticação Federada

Hoje, 20 Outubro
16h30m – 18h00m
Sala DS01

Autenticações (últimos 7 dias)

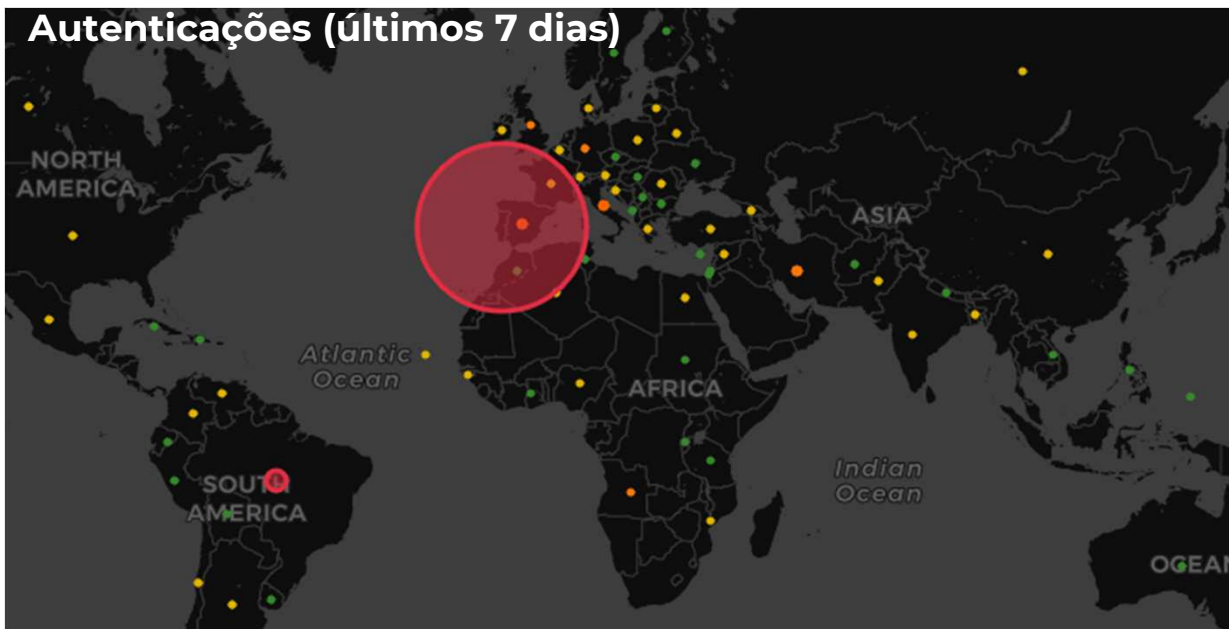

suporte@ciencia-id.pt

>82.000

Utilizadores Registados

FCCN UNIDADE DA FCT

jornadas.fcn.pt



Jornadas Computação Científica 2021

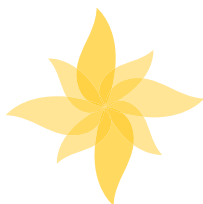

Pedro Simões – psimoes@fccn.pt

Patrocinadores Platina



Patrocinadores Ouro

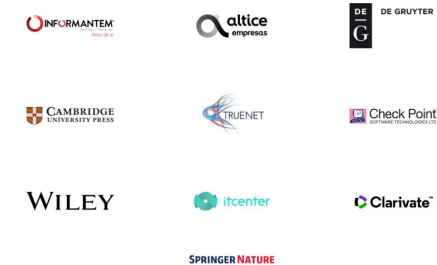

Patrocinadores Prata



Apoios



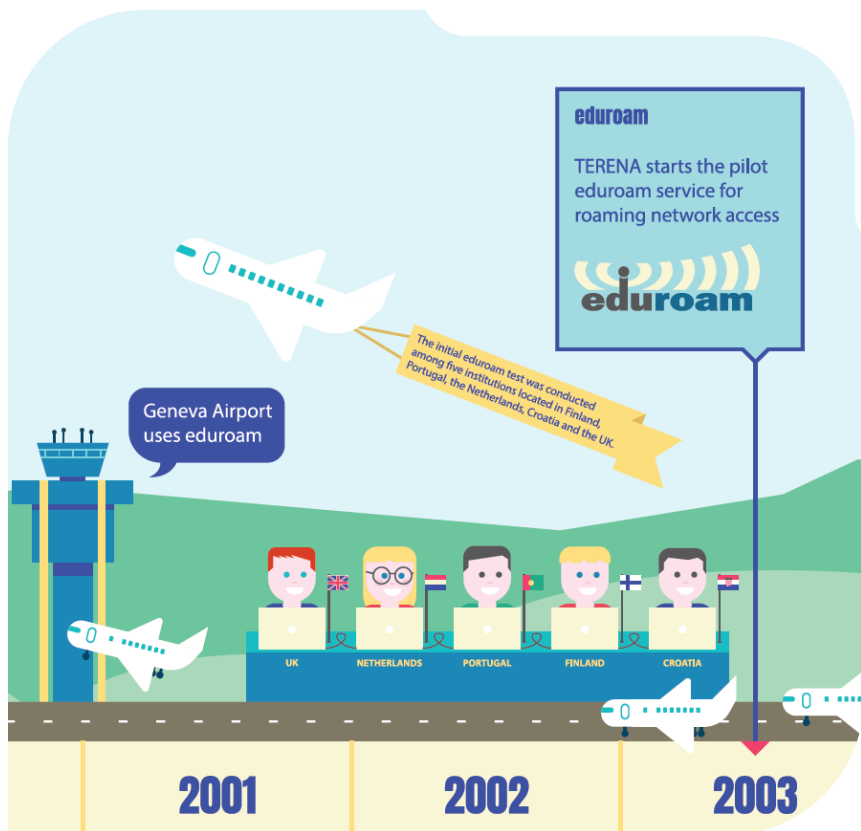

+ 4 Mil Milhões

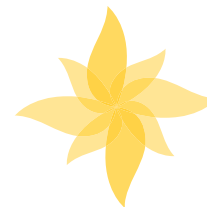

AUTENTICAÇÕES POR ANO

eduroam WORLDWIDE

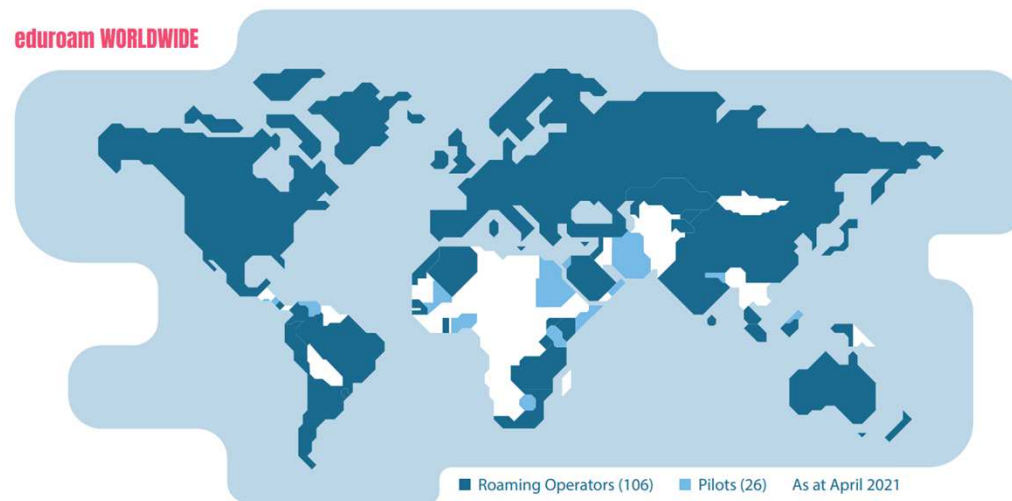

106

PAÍSES

+ 60 000

HOTSPOTS



O QUE É O OPENROAMING?

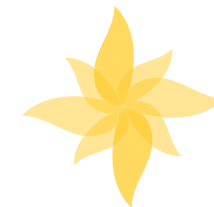

Fornecedores de Acesso/fabricantes

Fornecedores de Identidade/Terminais

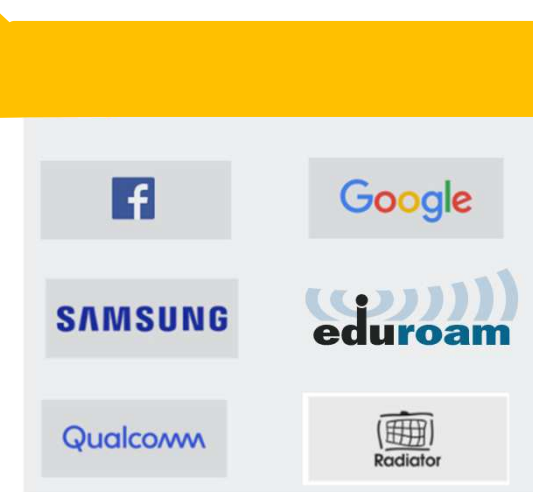
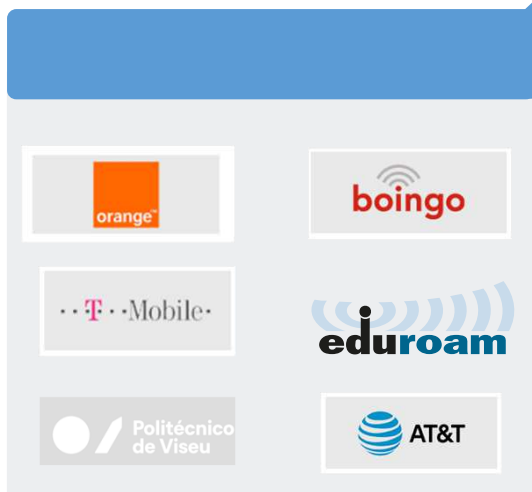

“Seamless and interoperable services experience on Wi-Fi within the global wireless ecosystem”



MODELO DE FUNCIONAMENTO

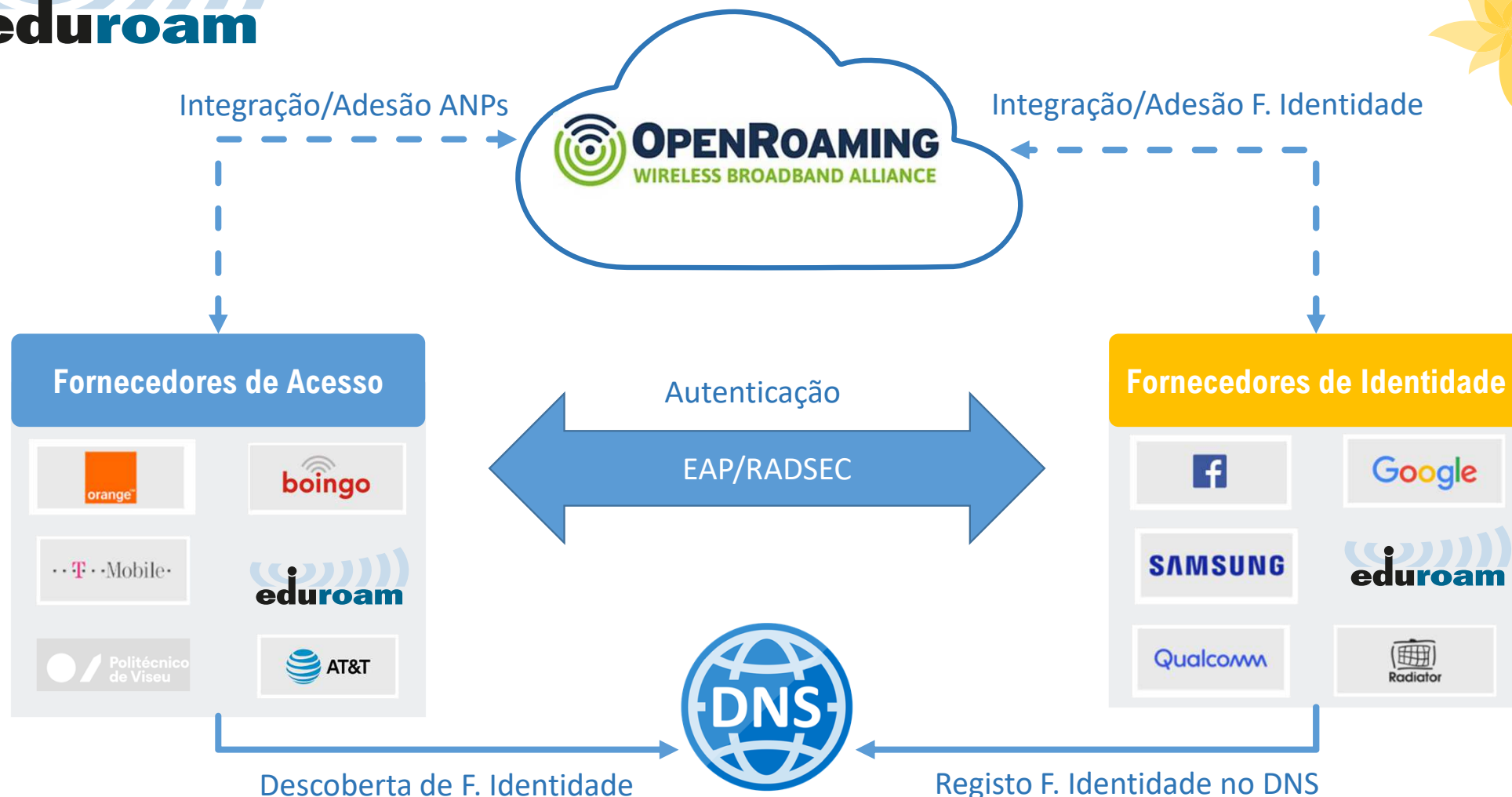



DENTRO DAS INSTITUIÇÕES EDUROAM

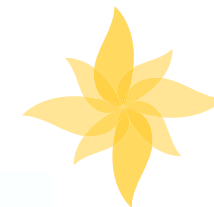

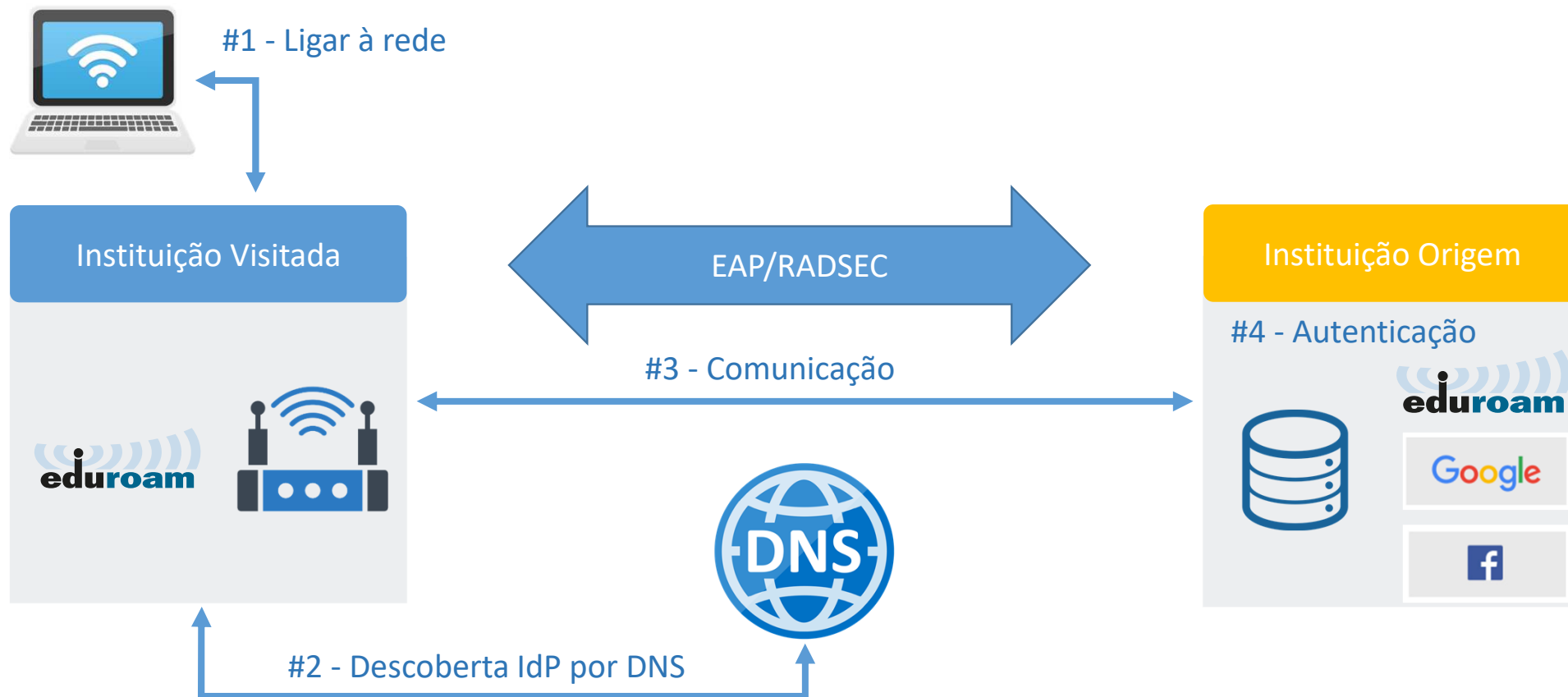
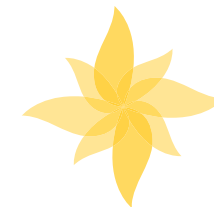

FORA DAS INSTITUIÇÕES EDUROAM





“OPENS THE DOOR TO CREATE ONE GLOBAL WI-FI NETWORK”

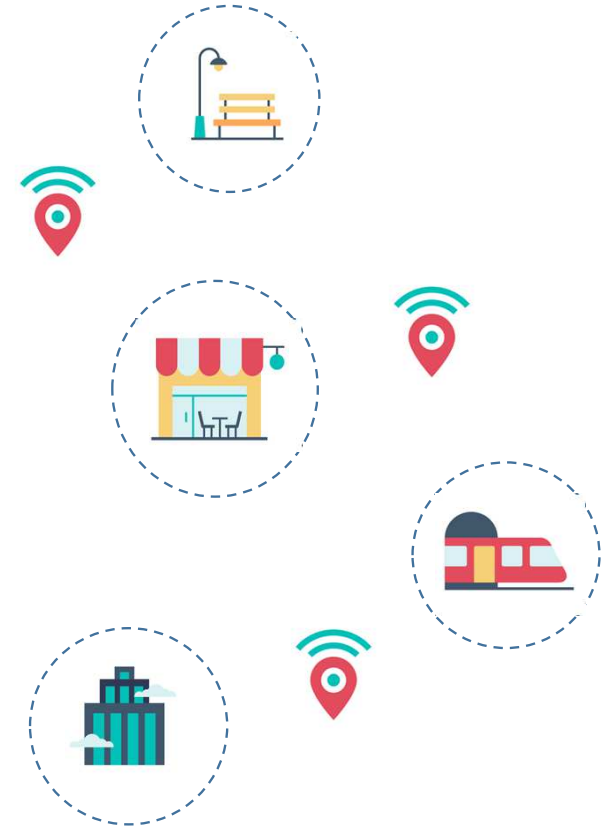
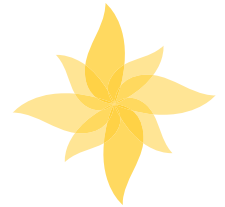

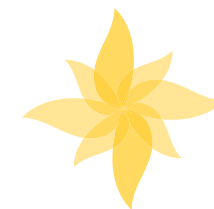

Obrigado

Pedro Simões – psimoes@fccn.pt

ESTÚDIO VÍDEO

João Santos

joao.santos@fccn.pt



Patrocinadores Platina



Patrocinadores Ouro

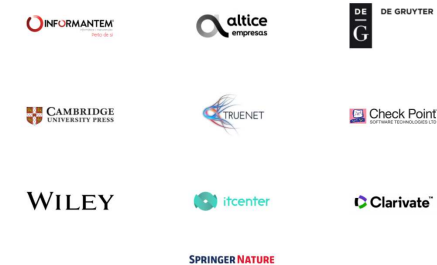

Patrocinadores Prata



Apoios



DESTINATÁRIOS

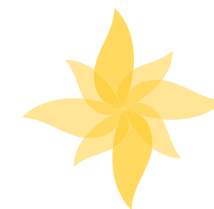

GRÁTIS para:

- Instituições da rede RTCS
 - Os serviços são dirigidos para toda a comunidade académica e científica nacional.
 - Gabinetes de Comunicação
 - Equipas de Informática
 - Equipas de Audiovisuais e Multimédia
 - Equipas de e-Learning
 - Professores
 - Alunos
 - Investigadores

- Aderentes da NAU e no âmbito da criação de MOOC

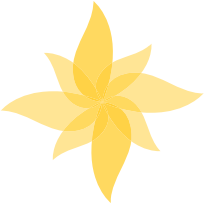

TECNOLOGIA

- Estúdio profissional com qualidade Broadcast;
- 80m2 de estúdio com Chroma Key;
- Cenografia virtual;
- Três câmaras de vídeo profissionais (4K);
- Teleponto;
- Iluminação;



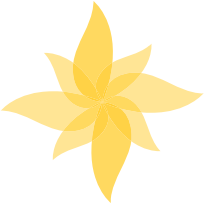

TECNOLOGIA

- Estúdio profissional com qualidade Broadcast;
- 80m2 de estúdio com Chroma Key;
- Cenografia virtual;
- Três câmaras de vídeo profissionais (4K);
- Teleponto;
- Iluminação;



PRODUÇÃO DE CONTEÚDOS AUDIOVISUAIS

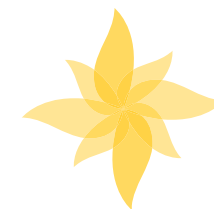

- Gravação de vídeos, aulas, Mooc



PRODUÇÃO DE CONTEÚDOS AUDIOVISUAIS

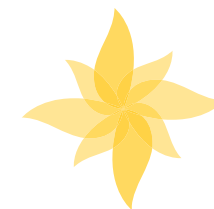

- Entrevistas
- Programas Televisão
- Webinar



PRODUÇÃO DE CONTEÚDOS AUDIOVISUAIS

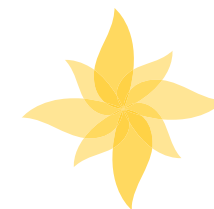

- Integração com outros serviços:
Videoconferência – Colibri
 - Dia da Internet Segura 2021
 - Urbact da Direção Geral do Território
 - 500 Anos Fernão Magalhães - WebRTC
- Videocast, Educast e Banco de Vídeo.

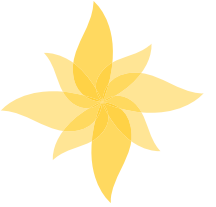

PRODUÇÃO DE CONTEÚDOS AUDIOVISUAIS

- Gravação de voz-off
 - Instituto de Astrofísica e Ciências do Espaço
- Gravação Podcast
 - Maratona da Saúde



AUTONOMIA

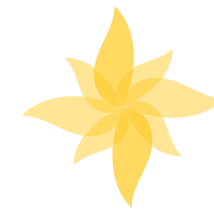

- Kits Produção Vídeo

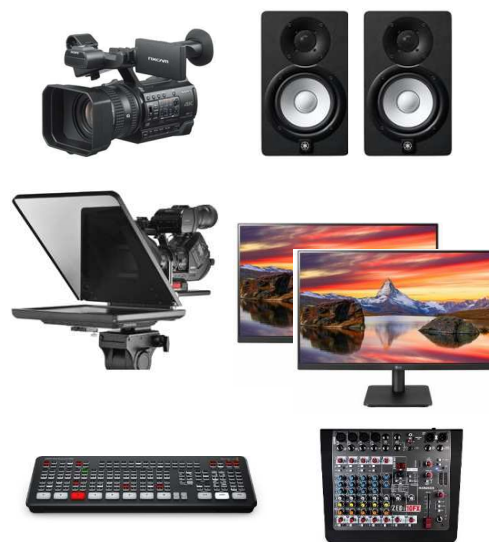

TECNOLOGIA EM IMPLEMENTAÇÃO

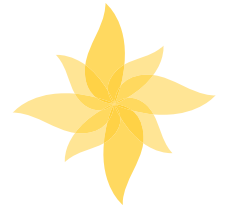

- Futura implementação de vídeo sobre IP – NDI
 - Interligação vídeo na rede interna e internet



SESSÃO – SERVIÇOS MULTIMÉDIA

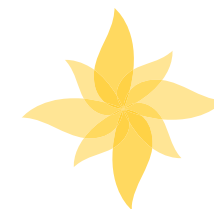

- Quarta 20 outubro
- Sala DS02
- 16:30 às 18:00

OBRIGADO!

GESTÃO DE DADOS DE INVESTIGAÇÃO

Zapping

Filipa Pereira



[8A13-4EA4-A512](https://orcid.org/0000-0002-5732-9996)



[0000-0002-5732-9996](tel:0000-0002-5732-9996)

20 de outubro de 2021

Patrocinadores Platina



Patrocinadores Ouro



Patrocinadores Prata



Apoios



PROMOVER A CIÊNCIA ABERTA

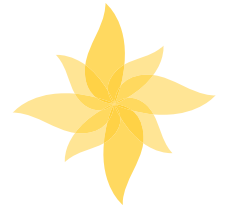

Disponibilização aberta de **dados** resultantes de investigação realizada com financiamento público



Ciência mais **eficiente, transparente, confiável e reprodutível**



Fonte: <https://en.unesco.org/sites/default/files/open-science-brochure-en.pdf>

POLÍTICA DE GESTÃO E PARTILHA DE DADOS DE INVESTIGAÇÃO

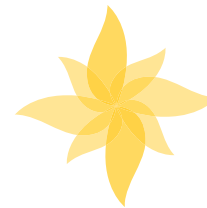

AS OPEN AS POSSIBLE, AS CLOSED AS NECESSARY

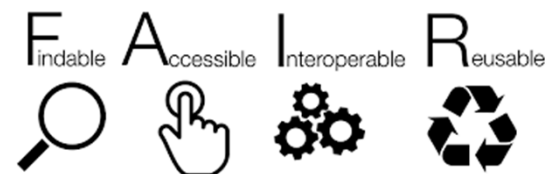

SISTEMA DE PLANOS DE GESTÃO DE DADOS

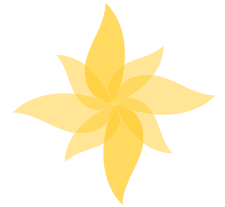

Plano Gestão de Dados:

- Como serão os dados criados e documentados;
- Quem pode aceder aos dados;
- Como reutilizar os dados;
- Como serão armazenados e preservados.

Plan and follow your data

Create machine actionable DMPs.

Configure to best fit your discipline.

Link to EOSC components out of the box.

Share easily in your repository.

Bring your Data Management Plans closer to where data are generated, analysed and stored.

argos



Brevemente!

SERVIÇO DE REPOSITÓRIO DE DADOS DE INVESTIGAÇÃO

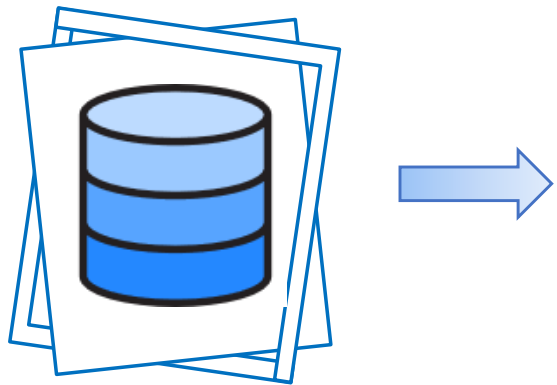
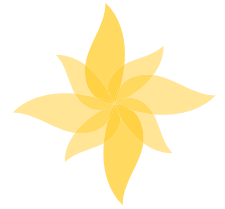

- Possibilitar à comunidade de ensino e de investigação o depósito dos seus resultados.
- Este serviço permitirá **albergar, preservar e dar acesso** a conjuntos de dados científicos.

8º FÓRUM GESTÃO DE DADOS DE INVESTIGAÇÃO

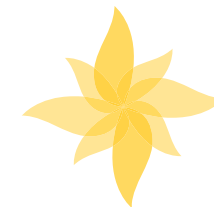

SAVE THE DATE

25 e 26 DE NOVEMBRO 2021
UNIVERSIDADE DE COIMBRA

8º FÓRUM
GESTÃO DE DADOS
DE INVESTIGAÇÃO

ACAAP | Repositórios Científicos de Acesso Aberto de Portugal

Organização

REPÚBLICA PORTUGUESA
CIÊNCIA, TECNOLOGIA

FCT
Fundação para a Ciência e a Tecnologia

UNIVERSIDADE DE COIMBRA

UNIVERSIDADE DE COIMBRA

The poster features a blue and green grid pattern on the left, a central blue circle with 'SAVE THE DATE', and various logos including ACAAP, FCT, and the University of Coimbra. The background is a light blue network diagram.

Inscrições
abertas até
19 de
novembro!



Inscrições:

<https://www.eventbrite.com/e/registo-8o-forum-de-gestao-de-dados-de-investigacao-161650538111>

GRUPOS DE TRABALHO – FÓRUM GDI

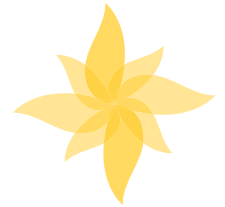

FÓRUM
GESTÃO DE DADOS
DE INVESTIGAÇÃO



FCT
Fundação
para a Ciência
e a Tecnologia



Participantes de **várias instituições**, com **diferentes níveis de experiência**
e associados a **diferentes domínios científicos**



Enriquecimento da **partilha de ideias** e de **boas práticas** na GDI

Grupo de Trabalho
Repositórios de Dados:
Tecnologia, organização e
certificação

Grupo de Trabalho
Formação e competências
para Gestão e Dados FAIR

Grupo de Trabalho
Políticas, Estratégias e
Recomendações GDI

WEBSITE GDI

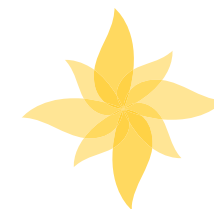

A disponibilizar
em breve!

APOIO



RECURSOS FORMATIVOS



OUTROS RECURSOS



COLABORAÇÃO



FAQ'S

INICIATIVAS E PROJETOS – CIÊNCIA ABERTA & GDI

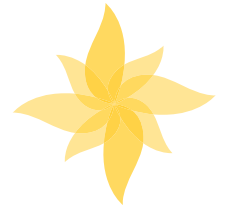

Alinhamento de
iniciativas
nacionais e
internacionais



Colaboração com diversos parceiros



MAIS INFORMAÇÃO SOBRE GDI

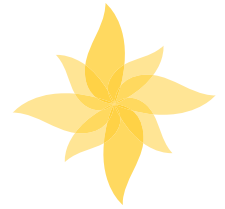

Jornadas FCCN 2021

Dia 20 de outubro, 14H30

***Sessão - “Armazenar, preservar e promover o acesso
ao conhecimento aberto em Portugal”***

Muito Obrigada!

Filipa Pereira
dados@rcaap.pt

Patrocinadores Platina



Patrocinadores Ouro

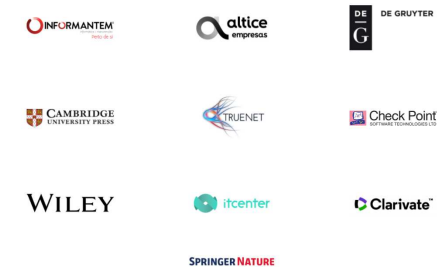

Patrocinadores Prata



Apoios



Jornadas Computação Científica 2021



InAcademia
ONLINE STUDENT VALIDATION

GÉANT



inacademia.org

info@inacademia.org

Patrocinadores Platina



Patrocinadores Ouro

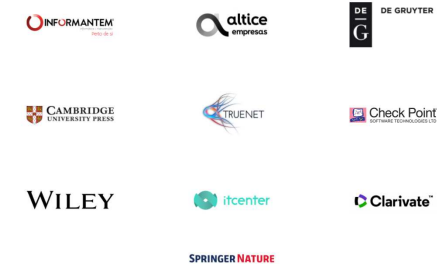

Patrocinadores Prata



Apoios



Este utilizador é um estudante,
funcionário ou docente ?



Verificação em tempo real da
afiliação académica do
utilizador



Sim / Não



Serviços de descontos para estudantes solicitam muita informações para verificar a afiliação do utilizador

É solicitado ao utilizador para fornecer documentação, que pode expor mais informações do que a necessário.

Este utilizador é um estudante, funcionário ou docente ?



InAcademia protege os dados dos utilizadores durante o processo de adesão ao desconto



GEANT cobra uma taxa aos serviços comerciais



Este utilizador é um estudante, funcionário ou docente ?



Sim / Não



1. Este utilizador é um estudante?

2. Por favor autentique-se na sua instituição

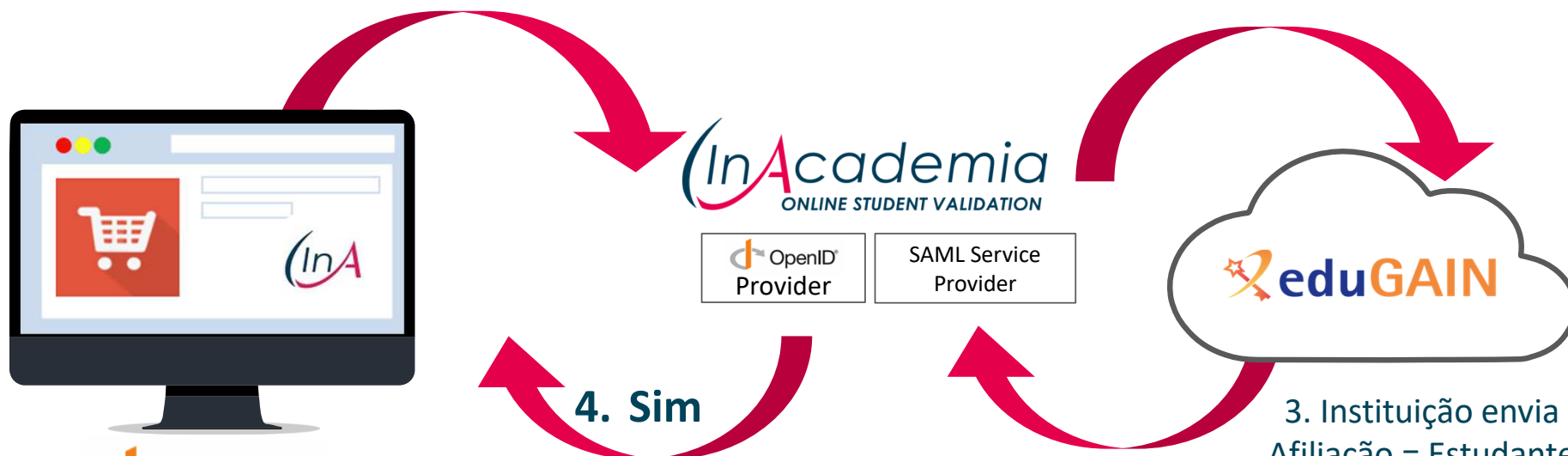

Retorna ID TOKEN

Sub = Identificador Anonimizado

Requested_scopes: {"values": ["openid", "persistent", "student"]}

jornadas.fccn.pt

InAcademia: um proxy que beneficia Federações, Fornecedores de Identidade, Utilizadores e Serviços comerciais



Solução mais leve em alternativa à integração na federação de identidade nacional



Minimiza o envio de dados pessoais dos utilizadores a entidades terceiras



Remove a necessidade de integração individual de serviços comerciais

... para reduzir o esforço de suporte e aumentar a privacidade



Colaboração com as Federações na integração de casos de uso Nacionais

GÉANT coordena as negociações jurídicas e comerciais

A equipa inAcademia coordena a integração

- Regista o serviço,
- Suporte na preparação
- Disponibiliza 'early life support' e monitorização



Steering Committee supervisiona as actividades



Obrigada!

inacademia.org



noc@fccn.pt

jornadas.fccn.pt

RCTSaai

Sistemas de Autenticação
Federada



Hoje, 16h30m – 18h00m
Sala DS01

Jornadas Computação Científica 2021



NAU – SEMPRE A APRENDER!

<https://nau.edu.pt>

info@nau.edu.pt

Patrocinadores Platina



Patrocinadores Ouro

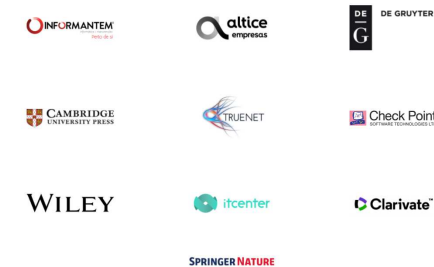

Patrocinadores Prata



Apoios



MOOC

Curso Online Aberto e Massivo



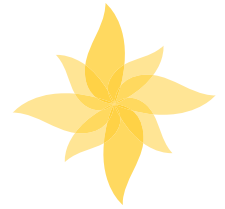

MOOC

Plataformas internacionais



UDACITY



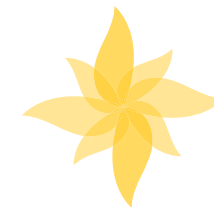

140,000 utilizadores

270,000 inscrições

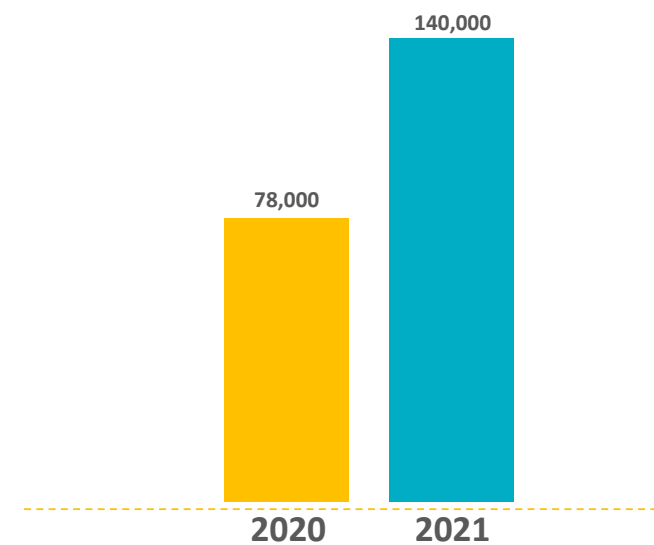

Mobilidade





O que quer aprender hoje?

NAU - Sempre a aprender!

Conheça os cursos

O que quer aprender hoje?



Cursos em destaque



Gratuito

Introdução à Programação



Gratuito

Introdução à Publicidade Digital



Gratuito

Sustentabilidade Ambiental -
Mobilizar, Observar e
Operacionalizar



Gratuito

Animação com Idosos



Melhorias

Apresentação

Design

Comunicação

Marketing

Melhorias

Infraestrutura

Tecnologia

Disponibilidade



Open Source

Richie LCMS

Open edX



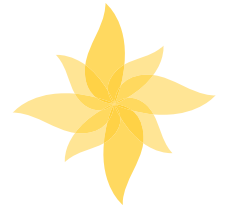

Venha conhecer a NAU!

<https://www.nau.edu.pt>

Sala DS01

21 de Outubro, 9h30 – 13:00

“O conhecimento resulta da adequação entre a mente e o mundo.”

Tommaso Piazza

“O que é o conhecimento”, 2019

Patrocinadores Platina



Patrocinadores Ouro

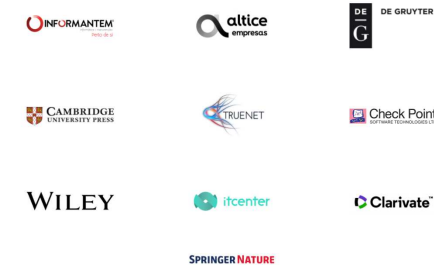

Patrocinadores Prata



Apoios



EDUCAST

Grave as suas aulas com o Educast

Nelson Dias

Patrocinadores Platina



Patrocinadores Ouro

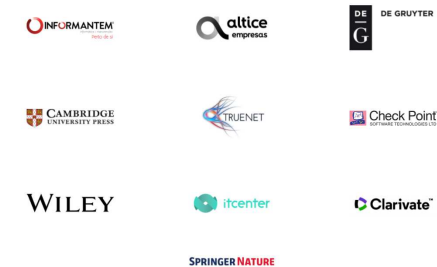

Patrocinadores Prata



Apoios



VIDEOS EDUCATIVOS

Qual é o lugar dos
vídeos educativos ?

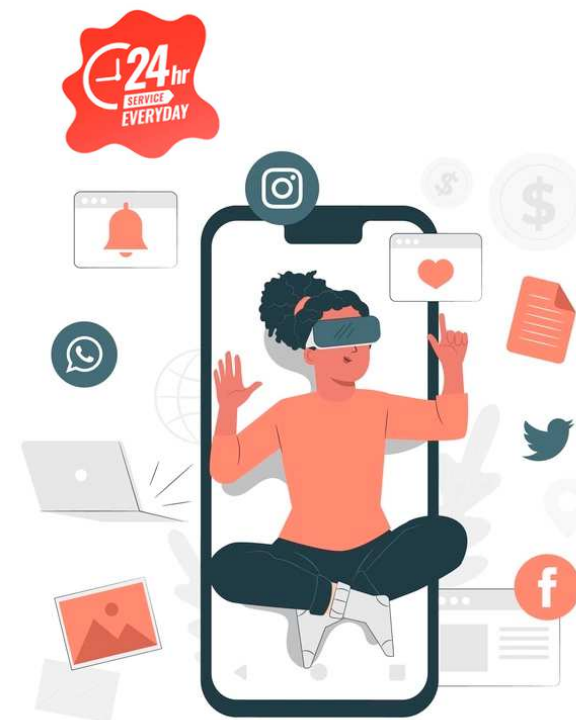
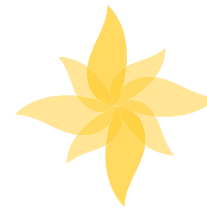

GRAVAÇÃO

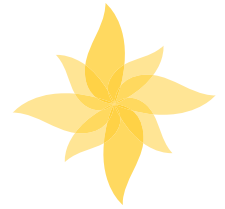

Aulas

Tutoriais

Workshops

Eventos



EDIÇÃO

Edição de videos educativos
via browser

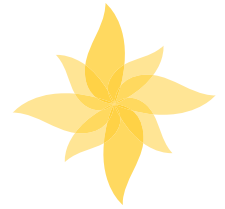

PUBLICAÇÃO

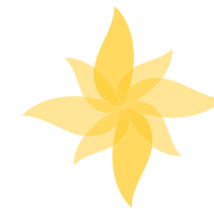

Múltiplos formatos

- Streaming
- Desktop
- Mobile

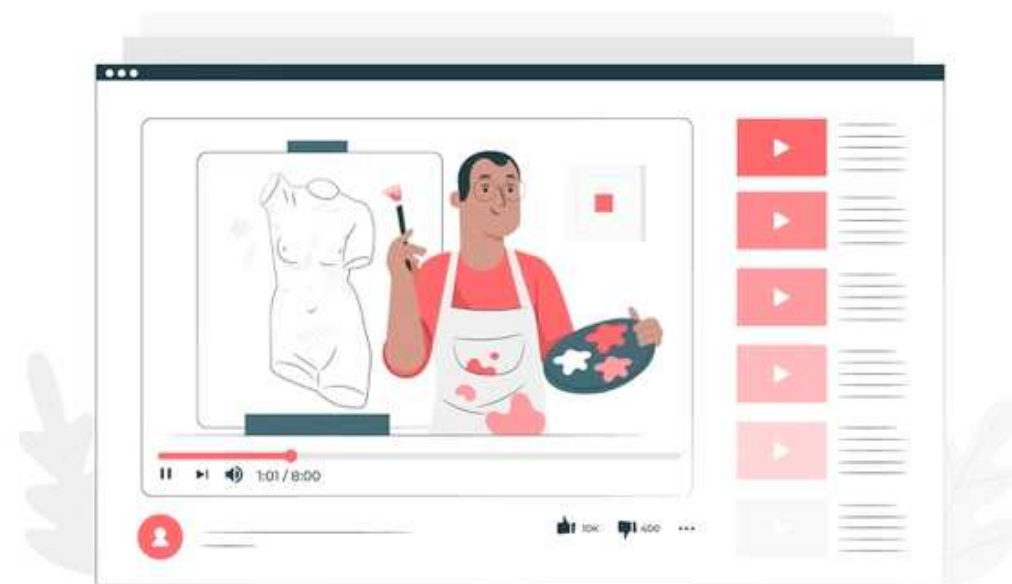

FORMATOS E LAYOUTS PUBLICAÇÃO

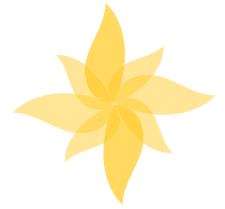

streaming

A screenshot of the Educast streaming player interface. It features a video player with a presenter's video feed on the left and a slide titled 'JORNADAS COMPUTAÇÃO CIENTÍFICA 2018' on the right. A sidebar on the right contains navigation options like 'Educast - grava, edita e publica', 'Portal Educast', 'Estatísticas', 'Gravar', and 'Editar'. Below the video player, there is a title 'Novo Player Educast HTML5', a 'Demonstração' label, the presenter's name 'Nelson Dias', and a '412 Visualizações' count.

desktop

A screenshot of the Educast desktop player interface. It shows a video player with a presenter's video feed on the left and a slide titled 'JORNADAS COMPUTAÇÃO CIENTÍFICA 2018' on the right. The slide content includes the event title, a list of sponsors, and the presenter's name 'Nelson Dias' with his email 'Nelson.dias@fccn.pt'. The video player shows a progress bar at 0:05 / 3:04.

mobile

A screenshot of the Educast mobile player interface. It displays a slide titled 'JORNADAS COMPUTAÇÃO CIENTÍFICA 2018' with a list of sponsors and the presenter's name 'Nelson Dias' and email 'Nelson.dias@fccn.pt'. The video player shows a progress bar at 0:06 / 3:04. The interface is optimized for a mobile screen.

INTEGRAÇÃO

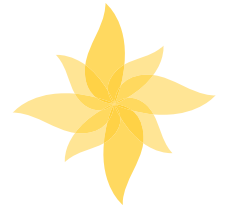

Websites

Learning Management Systems

Redes Sociais



Blackboard



NOVIDADES 2020/2021

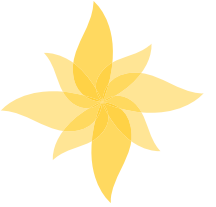

EDITOR DE VIDEO HTML5

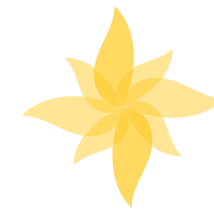

Editor via browser

- Metadados
- Edição
- Capítulos
- Branding



EDITOR DE VIDEO HTML5

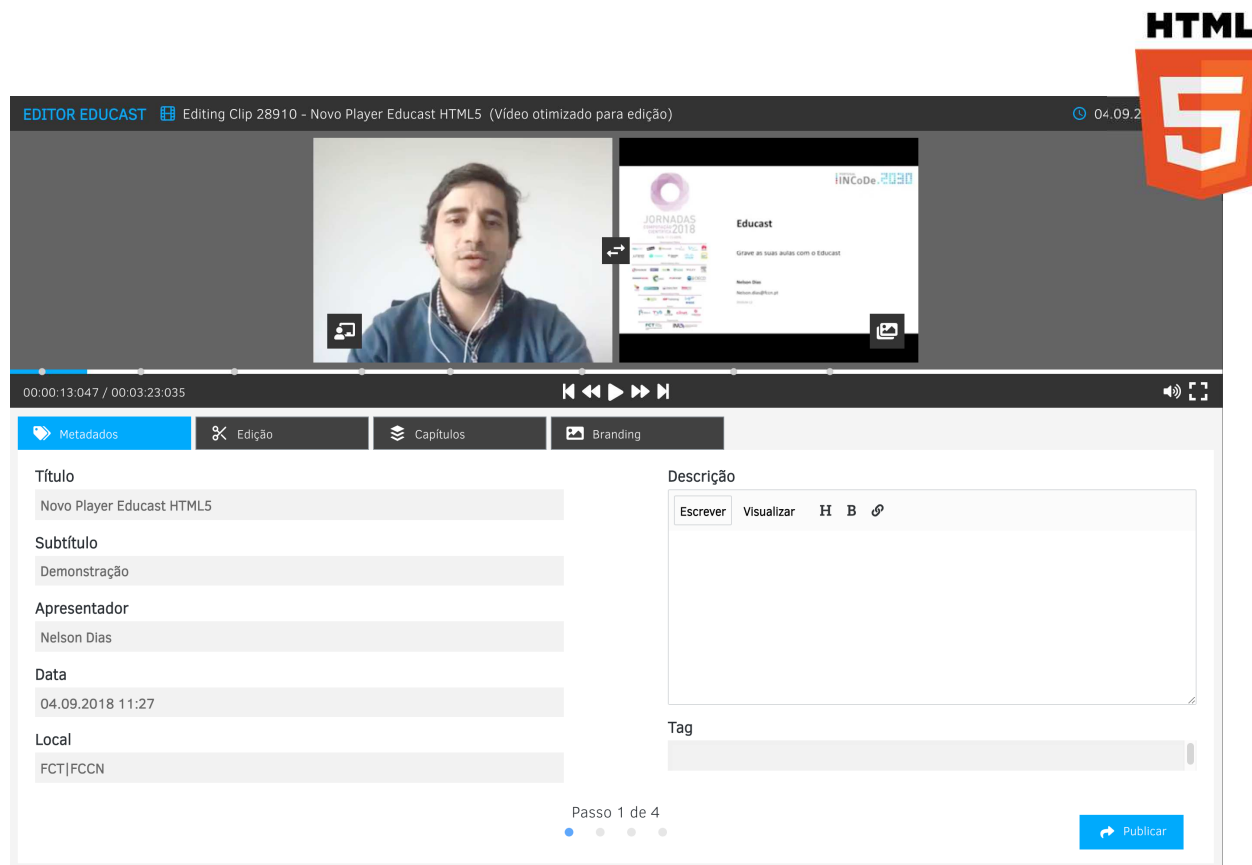

The screenshot displays the 'EDITOR EDUCAST' interface. At the top, it shows 'Editing Clip 28910 - Novo Player Educast HTML5 (Vídeo otimizado para edição)' and a timestamp of '04.09.2018'. The main video player area contains a video of a man speaking and a slide titled 'JORNADAS Educast' with the subtitle 'Gratuitas as tuas aulas com o Educast'. A large orange and white 'HTML5' logo is overlaid on the right side of the video player. Below the video player is a control bar with a progress indicator at '00:00:13:047 / 00:03:23:035' and playback controls. The bottom section features a navigation menu with 'Metadados', 'Edição', 'Capítulos', and 'Branding'. The 'Metadados' tab is active, showing fields for 'Título' (Novo Player Educast HTML5), 'Subtítulo' (Demonstração), 'Apresentador' (Nelson Dias), 'Data' (04.09.2018 11:27), and 'Local' (FCT|FCCN). To the right, the 'Descrição' section includes a rich text editor with 'Escrever', 'Visualizar', and 'H B' options, and a 'Tag' field. A 'Publicar' button is located at the bottom right. A progress indicator at the bottom center shows 'Passo 1 de 4'.

NOVO WEBSITE

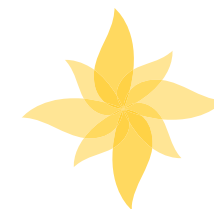

Website

- Pesquisa de conteúdos
- Responsivo
- Bright & dark mode
- Vídeos mais vistos
- Vídeos mais recentes

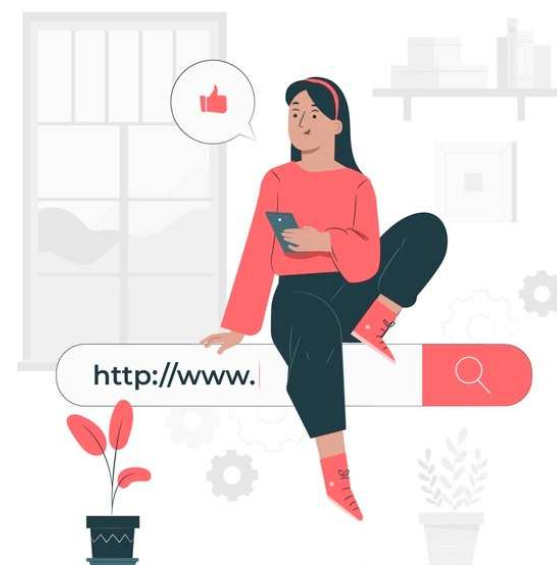

educast.fccn.pt

NOVO WEBSITE

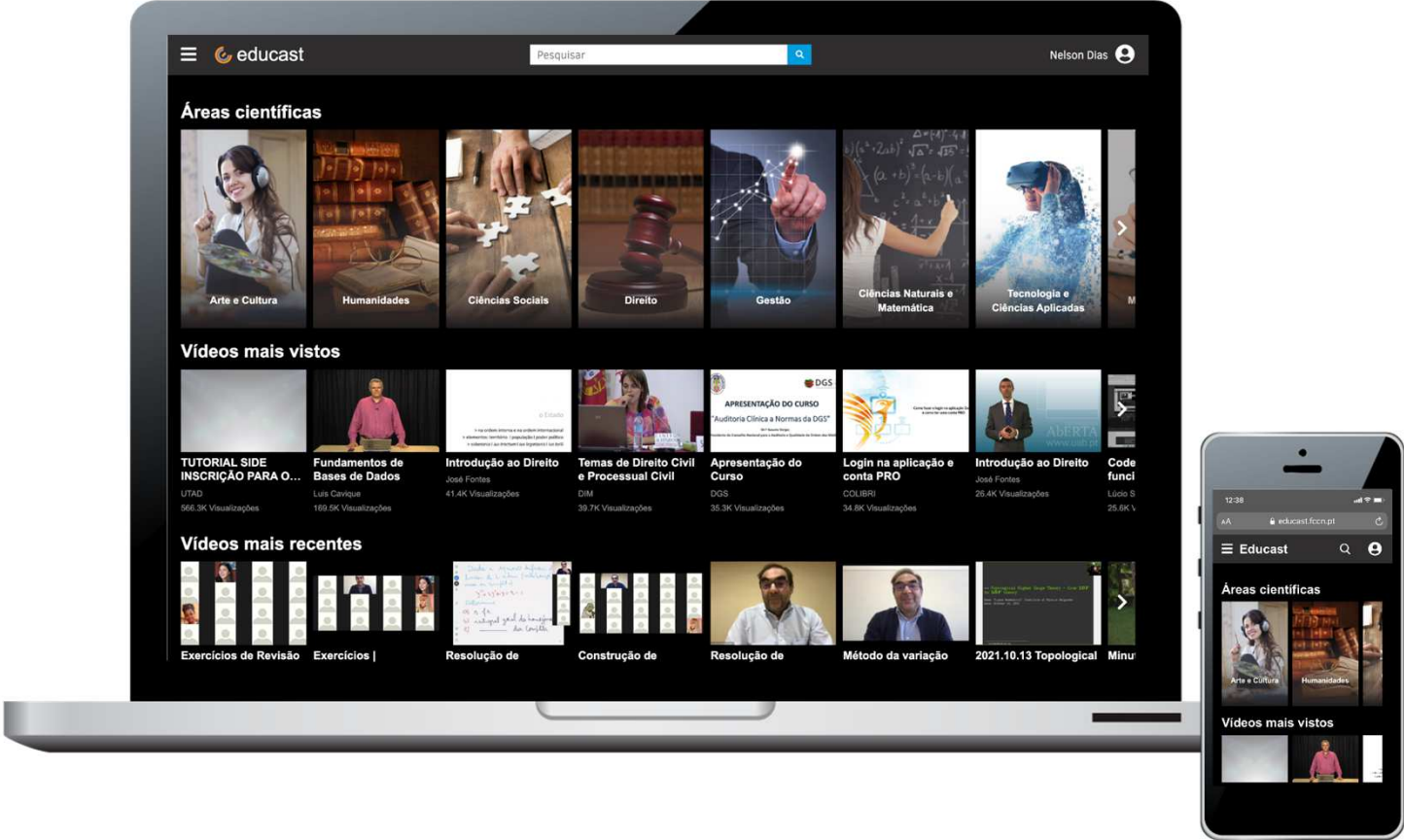
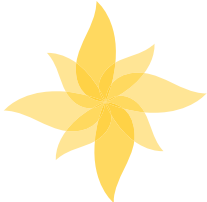

EDUCAST RECORDER

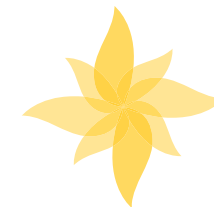

Versão beta (final 2021)

Sistemas operativos

- Windows
- Mac
- Linux



BOAS GRAVAÇÕES

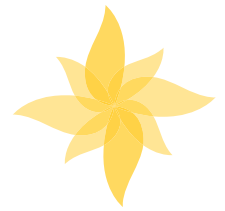

educast.fccn.pt

SERVIÇOS MULTIMÉDIA

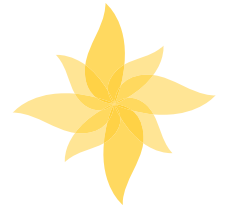

Soluções dedicadas à colaboração, comunicação
e ensino a distância

Dia 20 Outubro

14:30- 18:00



ARQUIVO.PT – NOVIDADES ÉPOCA 20/21

Daniel.Gomes@fccn.pt

Patrocinadores Platina



Patrocinadores Ouro

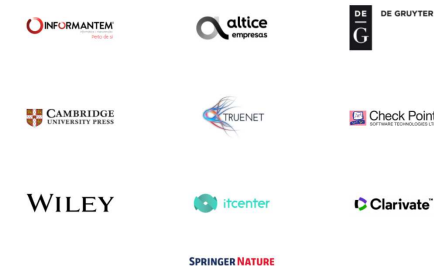

Patrocinadores Prata



Apoios



lpleiria.pt há 10 anos atrás vs. actual

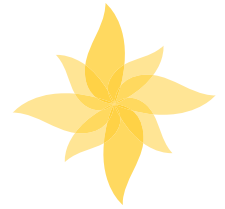

This screenshot shows the website lpleiria.pt as it appeared on January 22, 2011. The interface is dated and features a dark blue header with the text 'ARQUIVO.PT' and 'lpleiria.pt 22 Janeiro às 07:33, 2011'. A search bar is located in the top right. The main navigation menu includes 'IPL', 'Cursos', 'Estudantes', 'Bibliotecas', 'I&D+i', 'Serviços e Recursos', and 'Mobilidade'. The content area is divided into several sections: 'Comunicação' with links to various schools; 'Conselho Geral do IPL'; 'Título de Especialista'; 'Relatório de Bolonha 2009/2010'; 'Documentos em Discussão Pública'; 'Prevenção da Corrupção e Infrações Conexas'; and 'Bolsa Permanente de Docentes/Formadores'. A 'novidades' section highlights the creation of a 'Formação para executivos' program. A 'destaque' section reports on 'Mestrados IPL' results. On the right side, there are three small logos: 'GABINETE DE ACESSO AO ENSINO SUPERIOR', 'ESTUDANTES EXTRANJEROS', and '2010-2011 PLANO ESTRATÉGICO'. A left sidebar contains a 'Tabela' with a year selection dropdown from 2004 to 2020.

This screenshot shows the current website of the Instituto Politécnico de Tomar (IPT). The header features the IPT logo and navigation links for 'INTERNACIONAL', 'CANDIDATO', '@IPT', 'LOGIN', and 'EN'. The main banner is a large image of students celebrating, with the text 'Bem-Vindos ao IPT!' and 'Porquê estas cores?'. Below the banner, it announces 'Matrículas 1º ano - 1ª vez ONLINE' and 'Concurso Nacional de Acesso | Licenciaturas Cursos Técnico Superior Profissionalis'. The website has a modern, clean design with a white background and blue accents.

Pesquise milhões de imagens sobre o passado!

Serviço inovador à escala mundial

1 800 milhões de imagens do passado da Web

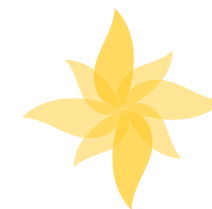









Menu **ARQUIVO.PT** Opções

Q seleção nacional futebol Pesquisar

1996 1 Jan 2021 21 Mai

Páginas **Imagens** Pesquisa avançada

Cerca de 9.771.819 resultados desde 1996 a 2021

 → miragens.abola.pt/media.aspx?... 3 Novembro 2016 às 22:11	 → jornaldoalgarve.pt/portugal-gole... 5 Março 2012 às 07:07	 → jornaldoalgarve.pt/2011/03/port... 9 Março 2011 às 20:51	 → jornaldoalgarve.pt/2011/03/port... 3 Março 2011 às 18:10
 → tamedasousa.pt/alemanha-com... 24 Julho 2014 às 19:24	 → tamedasousa.pt/portugal-arme... 23 Outubro 2014 às 23:17	 → tamedasousa.pt/portugal-sobe... 11 Maio 2014 às 23:32	 → vip.pt/mario-centeno-portugues... 6 Janeiro 2018 às 20:48

Narrativas automáticas com ContaMeHistorias.pt

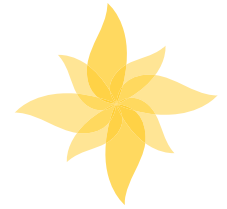

ARQUIVO.PT

Q lula da silva Pesquisar

1996 1 Jan 2021 30 Set

Páginas Imagens Narrativa Pesquisa avançada

Vai sair do Arquivo.pt para o ContaMeHistorias.pt

OK Cancelar

Início Pesquisar Sobre English

conta-me histórias
Crie uma narrativa de notícias sobre qualquer assunto

Q lula da silva opções avançadas

[Narrativa](#) [Termos relacionados](#)

Narrativa sobre **Lula Da Silva** durante os últimos 10 anos

07/2012 02/2016 09/2019

- Notícias relevantes entre **03/01/2011** e **02/07/2012**

- Filme sobre Lula da Silva candidato aos Óscares 2011
- Universidade da Madeira vai atribuir Doutoramento Honoris Causa a Lula da Silva
- Obama quer que Lula da Silva seja o próximo presidente do Banco Mundial
- Obama quer Lula da Silva na presidência do Banco Mundial
- Lula da Silva pede uma nova governação mundial no discurso no Prémio Norte-Sul
- O FMI não é solução para Portugal, diz Lula da Silva
- Lula da Silva insiste na reforma das Nações Unidas no doutoramento honoris causa
- Lula da Silva dedica 'honoris causa' a ex-vice-Presidente José Alencar
- Lula da Silva recebe hoje grau de doutor 'honoris causa' na Universidade de Coimbra

1ª recolha de websites de projetos financiados pela FCT

- 236 URLs relativos a 100 projetos
- 67% não tinham versão preservada no Arquivo.pt
- Exposição online em MemoriaFCT.wordpress.com

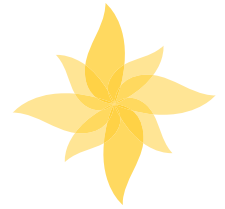

Memória Web da Investigação Científica

Sites de Unidades I&D e de Projetos financiados pela FCT

Início Lista de Unidades I&D Lista de projetos Sobre



Dourozone



Quimioterápicos –
Navigating through
marine-derived fungi



2Bio4Cartilage

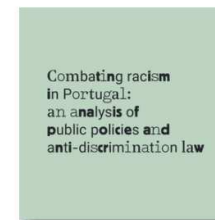

Combat



E-Dicionário de Termos
Literários

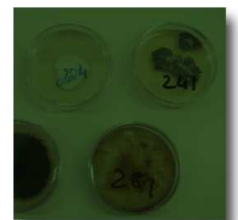

Projeto MycoStone

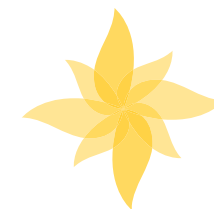

Arquivo.pt para recuperar citações

Recolhas especiais de recursos online em:

- Citados em artigos do RCAAP
- Citados em CVs do CIÊNCIAVITAE

Malaysian Journal of Library & Information Science, Vol. 16, no. 3, December 2011: 17-29

Death of web citations: a serious alarm for authors

Completar páginas em bloco automaticamente

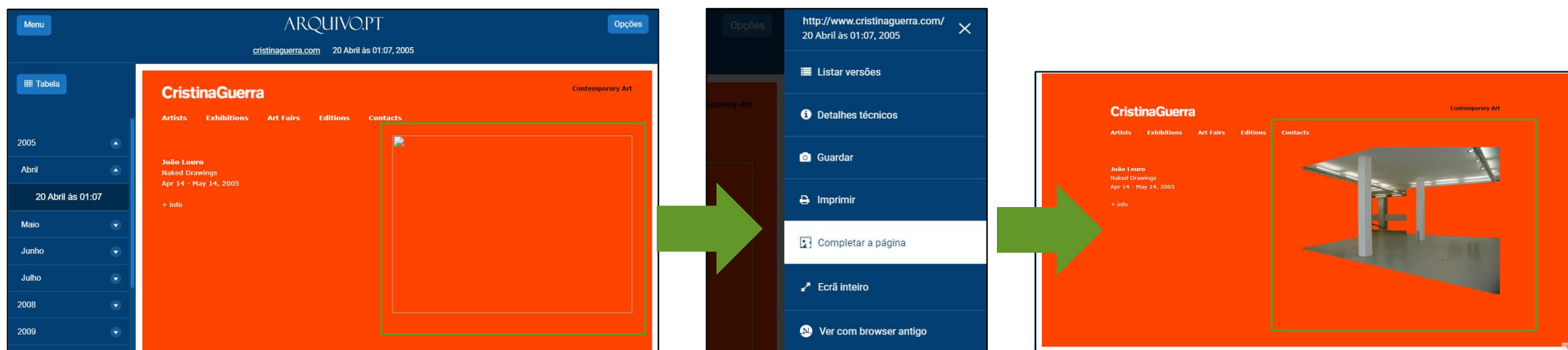

Completadas 17 milhões de versões de páginas do Jornal Público

arquivo.pt/arquivo404

acabe com as **ligações quebradas** no seu site!

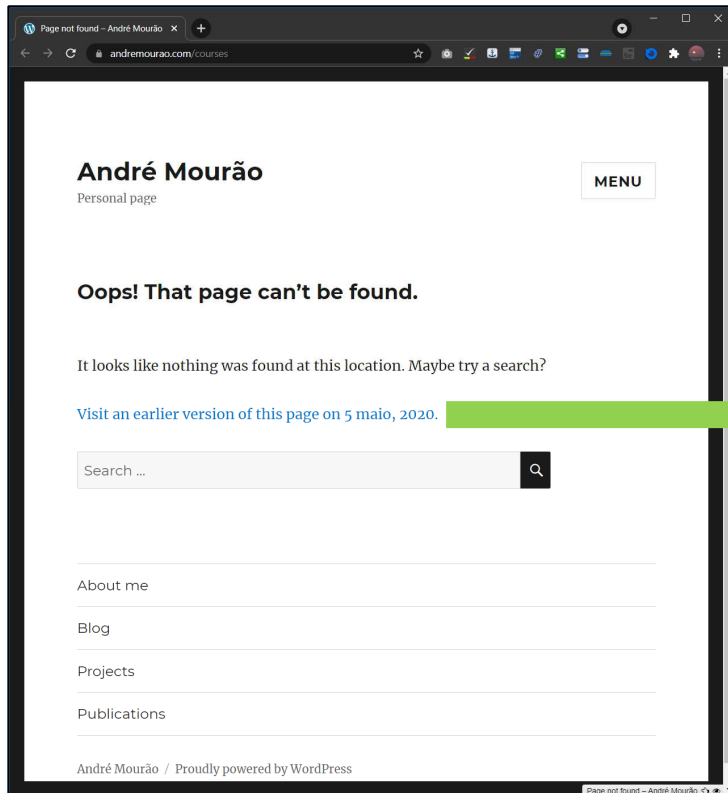

Página atual



Página **preservada** no Arquivo.pt

Divulgue o prémio anual Arquivo.pt 2022!

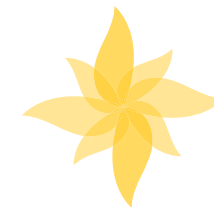

Prémio Arquivo.pt
2022

Concorra até 4 de maio

VIAJE no TEMPO

e ganhe 10.000€

Crie um trabalho individual ou em grupo que use o Arquivo.pt

1º Classificado 10.000€
2º Classificado 3.000€
3º Classificado 2.000€
Menção honrosa

Saiba mais em arquivo.pt/premio2022



FCT Fundação para a Ciência e a Tecnologia

O Presidente da República



➤ arquivo.pt/premios

Vídeo vencedores Prémio 2021

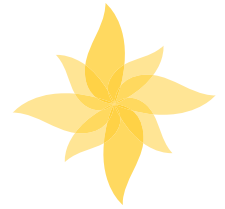

Arquivo.pt certificado como serviço público fornecedor de dados abertos (AMA)

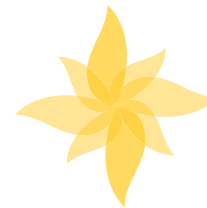

dados.gov
Portal de dados abertos da Administração Pública

20 conjunto de dados | 0 conjuntos de dados privados

- Partidos políticos em Portugal: websites e histórico no Arquivo.pt
0 | 0 | Pontual
- Websites do Governo Regional dos Açores e histórico de versões no Arquivo.pt
0 | 0 | Anual
- Agrupamentos de Escolas ou Escolas não Agrupadas: websites e histórico de
0 | 0 | Anual



ARQUIVO.PT

SERVIÇO PÚBLICO

CERTIFICADO

FORNECEDOR dados.gov CERTIFICADO

Formações do Arquivo.pt

29 formações online em 2020 (colibri.fccn.pt)

- Média de satisfação: 90%

Mais de 200 vídeos de formação

- arquivo.pt/videos



ARQUIVO.PT

15 DE MAIO ÀS 15 HORAS

CAFÉ COM O ARQUIVO.PT

APRESENTADOR: RICARDO BASÍLIO, CURADOR DIGITAL

The graphic features a circular portrait of Ricardo Basílio wearing a headset, a coffee cup icon, and the Arquivo.pt logo.



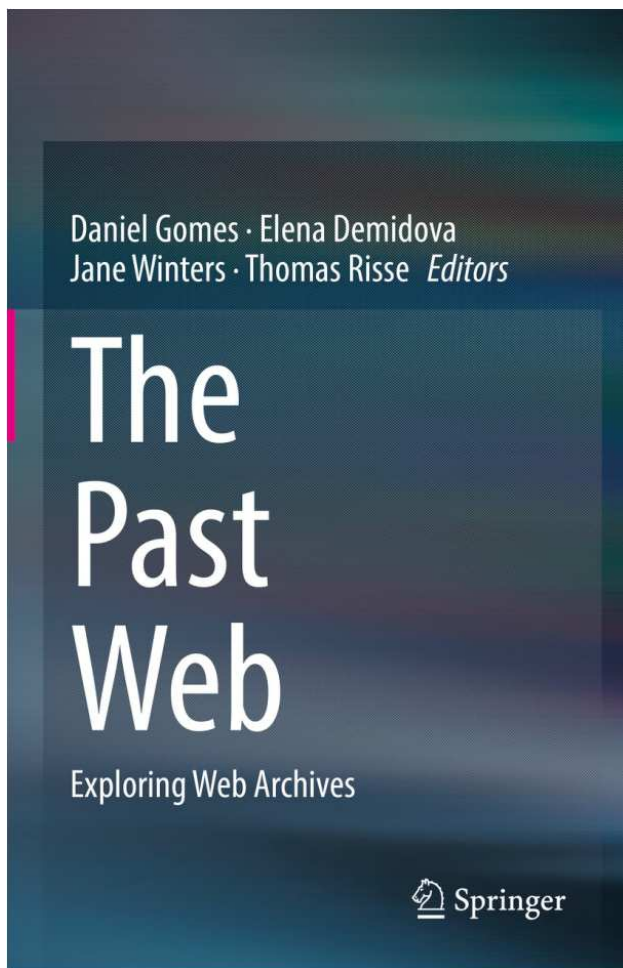
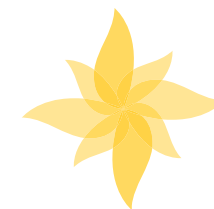

Descarregue já antes que esgote!!!

arquivo.pt/livro

Exclusivo aderentes b-ON
Até 6 de março aceda ao **livro**

The Past Web

Exploring Web Archives

FCCN 

NOVIDADES DOS SERVIÇOS DE COMPUTAÇÃO

Patrocinadores Platina



Patrocinadores Ouro

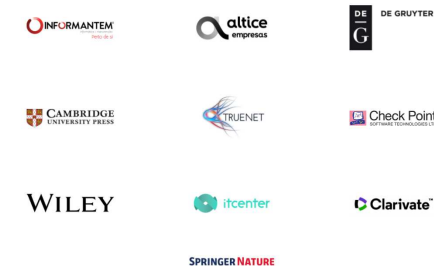

Patrocinadores Prata



Apoios



SERV. COMP. – AGENDA ZAPPING

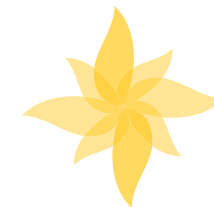

CLOUD OCRE

Oferta do Acordo Quadro em
serviços cloud IaaS+

[Saiba mais](#)



RNCA

Rede Nacional de Computação
Avançada

[Saiba mais](#)



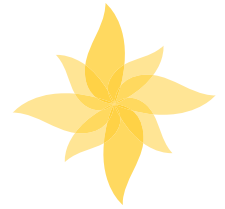













ACORDO QUADRO “CLOUD”



- Associação GEANT
- 1º acordo: 2017 – 2020. Concluído
- 2º acordo: janeiro de 2021 – 2024. Atual / Em vigor

ACORDO QUADRO “CLOUD”

Fornecedores
qualificados para
Portugal:

 		 	 
VSHN	Safespring	Sparkle	AppXite
		 	 
T-Systems	CloudSigma	Rackspace	SoftwareONE
 			
SoftwareONE	CloudFerro		

ACORDO QUADRO “CLOUD”

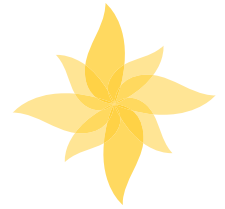

- Como usar?
- Executar uma compra ao abrigo do instrumento jurídico existente (não é subsidiada)
- Contacto de apoio: <https://www.ocre-project.eu/services/cloud-suppliers/country/portugal>

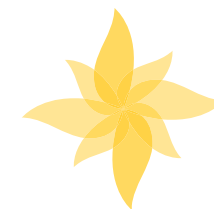

RNCA
REDE NACIONAL DE COMPUTAÇÃO AVANÇADA

RNCA

Rede Nacional de Computação
Avançada

Saiba mais

RNCA – REDE NACIONAL DE COM

Centro operacional	Plataforma	Sistema	Modelo computacional
MACC	Bob	360 <i>compute nodes</i> , cada um com dois Intel X86 Xeon E5-2680 (8 cores cada CPU) @2.7Ghz 2GB-RAM/core. 4 GPU do tipo Tesla T4	
LCA-UC	Navigator Navigator+	164 <i>compute nodes</i> , cada um com dois Intel Xeon E5-2697v2 (12 cores cada CPU) @2.7 GHz 32 <i>compute nodes</i> , cada um com dois Intel Xeon Gold 6148 (20 cores cada CPU) @2.4 GHz; 8 GPU do tipo Tesla V100	
HPC-UE	Oblivion & Vision	68 <i>compute nodes</i> , cada um com dois Intel Xeon Gold 6154 (18 cores cada CPU)@3.0 Ghz; 8 GPU do tipo Tesla A100	
INCD	Cirrus-A	CPU do tipo AMD EPYC 7501, cada um com 500GB-RAM e 64 cores; CPU do tipo AMD Opteron 2356, cada um com 32 GB-RAM e 8 cores CPU do tipo AMD Opteron 2356, cada um com 24 GB-RAM e 8 cores CPU do tipo Xeon E5-2680 v3 @ 2.50GHz, cada um com 200 GB-RAM e 24 cores 4 GPU do tipo Tesla T4, cada um 16GB-RAM e 2.560 cores;	
		Stratus	vCPU em AMD EPYC 7501, cada um com 500GB-RAM e 64 cores

Universidade de Évora com sistema computacional único em Portugal



Publicador: "Deucalion", o novo supercomp... +

https://www.publico.pt/2021/02/05/ciencia/noticia/de... 130%

Mais acedidos Começar aqui

Oferta especial: 15 meses por 72€ Assine já Entra

EM DESTAQUE FACE OCULTA JOVENS MEMÓRIA EUROPA - ESTADO DA UNIÃO ORÇAMENTO DO ESTADO 2022 GOVERNO ÚLTIM

FUNDAÇÃO PARA A CIÊNCIA E A TECNOLOGIA

Deucalion, o novo supercomputador deverá estar operacional em 2022

O investimento no novo supercomputador em Portugal ascende a um total de mais de 20 milhões de euros nos próximos três anos.

Lusa
5 de Fevereiro de 2021, 13:16

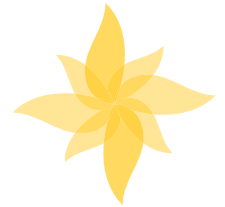

The screenshot shows a web browser window with the URL <https://eurocc.fccn.pt/calendariopt/>. The page features a dark blue header with the EuroCC Portugal logo and navigation links: **SOBRE EUROCC**, **HPC EM PORTUGAL**, **NOTÍCIAS E EVENTOS**, and **TREINO E SUPORTE**. The main content area has a large heading **Calendário Nacional** and a sub-heading **EuroCC - próximas formações:**. Below this, there are two entries: 1) **Calendário Nacional - Completo** with the URL <https://indico.eurocc.fccn.pt> - Plataforma de gestão de eventos. 2) **Quarta-feira Outubro 27 09:00 – Quinta-feira Outubro 28 18:00** for the course **Parallel I/O and data formats** at the **High Performance Computing Centre - U.Évora**, with the URL <https://www.oblivion.uevora.pt/parallel-i-o-and-data-formats/>.

RNCA

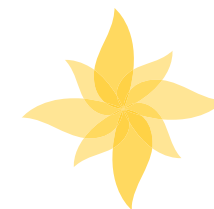

- Acessos A0 e A1 abertos em contínuo:
<https://www.fct.pt/apoios/Computacao/computacaoavancada/2edicao.p.html.pt>
- Oportunidades de treino em C.A.: <https://eurocc.fccn.pt/> + canais nas redes sociais

Jornadas Computação Científica 2021



PTCRIS

Cátia Laranjeira

catia.laranjeira@fccn.pt



3415-1354-5489

0000-0003-3952-8294

20 de outubro de 2021

Patrocinadores Platina



Patrocinadores Ouro

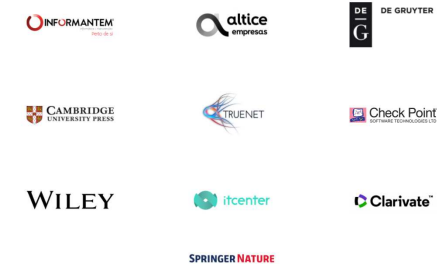

Patrocinadores Prata



Apoios



PTCRIS

Connected Research

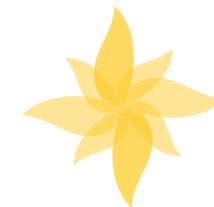

Registar uma vez,

Reutilizar sempre.

O Problema

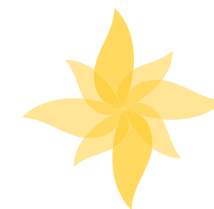

A Solução

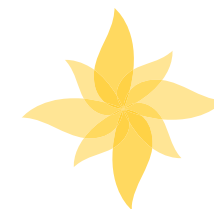

PTCRIS | ecossistema integrado

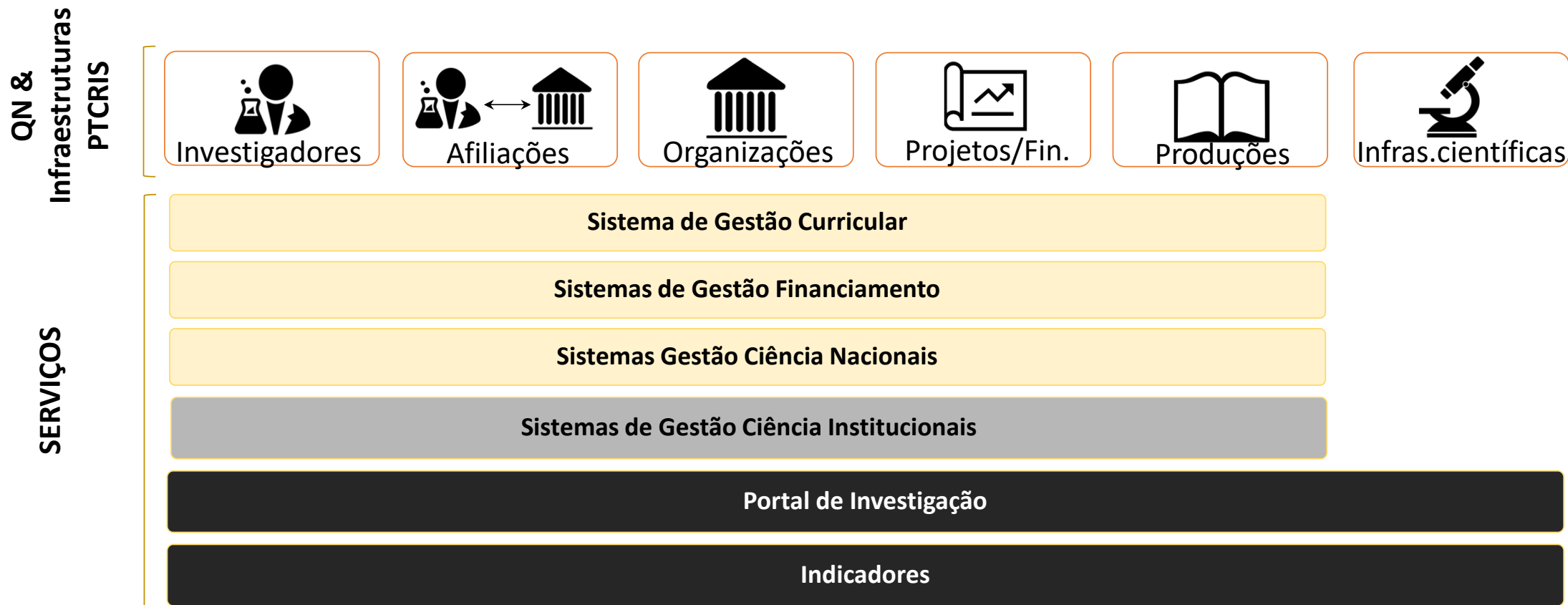
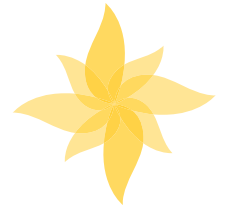

SoS = Sistema de Sistemas = ecossistema

PTCRIS | ecossistema integrado

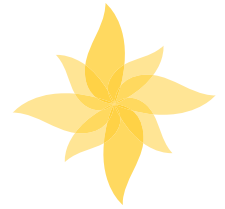

SoS = Sistema de Sistemas = ecossistema

REGISTO DE FINANCIAMENTO | NACIONAL/INTERNACIONAL

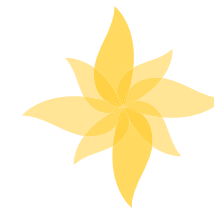

SCIPR@J

PTCRIS | ENRIQUECIMENTO **SCIPREJ**

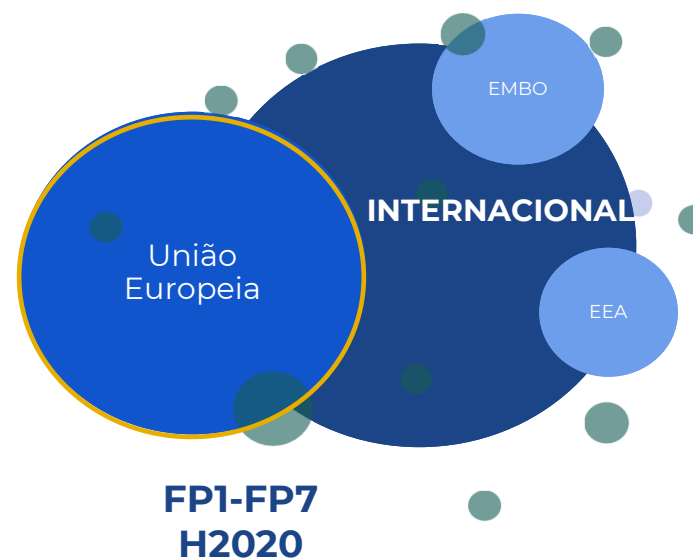
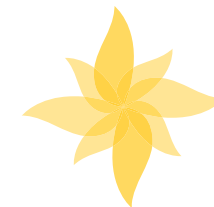

75 749 registos

PTCRIS | SCIPREJ (Data As a Service)

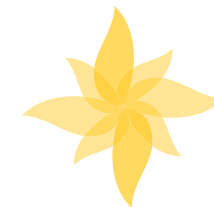

PTCRIS | ecossistema integrado

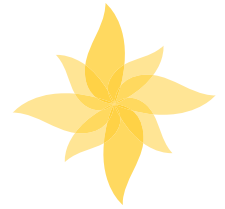

SoS = Sistema de Sistemas = ecossistema

CIÊNCIAVITAE | prioridades estratégicas

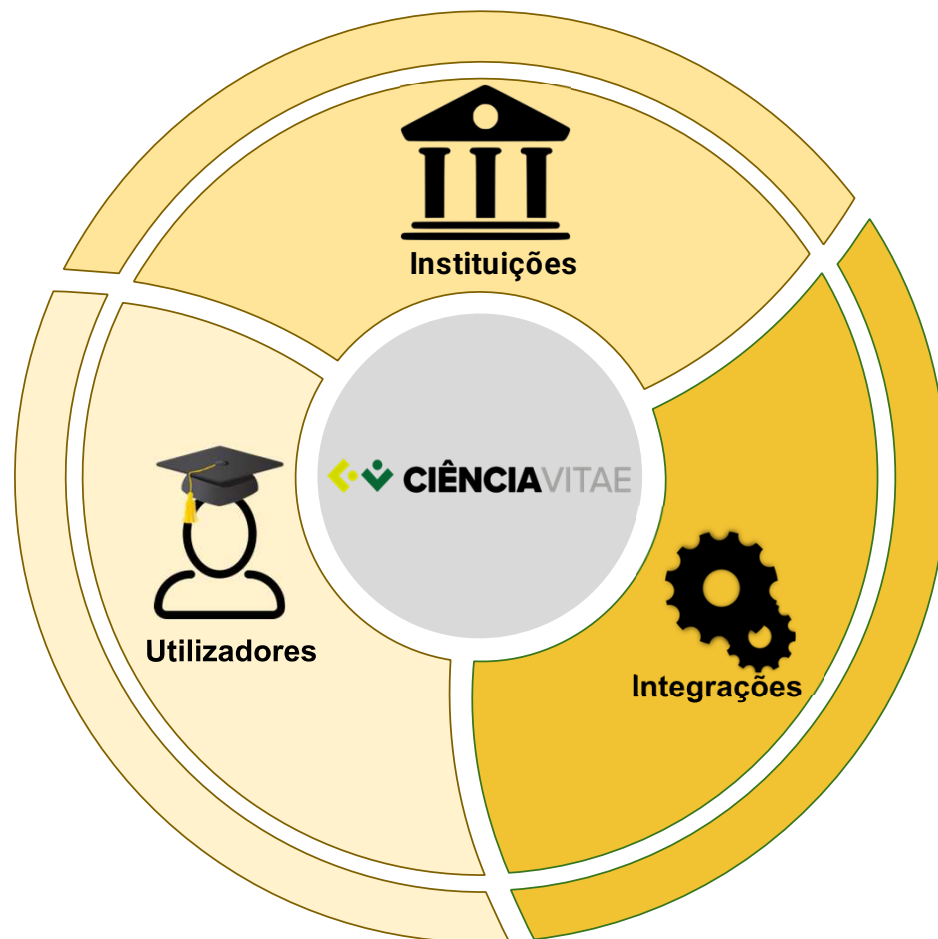
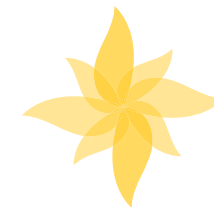

CIÊNCIAVITAE | Curadoria dados



CIÊNCIAVITAE João Moreira CIÊNCIAVITAE publicado

IDENTIFICAÇÃO FORMAÇÃO PERCURSO PROFISSIONAL **PROJETOS** PRODUÇÕES ATIVIDADES DISTINÇÕES

Projetos

Inconsistências

Data de início|Data de fim: data de início posterior à data de fim

► Tipo de participação *

▼ Informação de projeto *

Título do projeto *

malaria ໒໕໒໕

Pesquise ou introduza o título do projeto

Descrição

4000 caracteres restantes.

Tipo de financiamento *

Bolsa

Data de início

2020 Mês Dia

Data de fim

1999 Mês Dia

CIÊNCIAVITAE | *website*



NOVO!

 CIÊNCIAVITAE

[Destques](#)

[Encontrar CVs](#)

[Login](#)

EN



Novas funcionalidades!

24 Setembro, 2021



Esteja informado sobre os últimos desenvolvimentos na plataforma: novas funcionalidades, melhorias e correcções. Para saber mais, aceda [aqui](#).



Adeus DeGóis e FCT|SIGcv

14 Setembro, 2021



Em Setembro, despedimo-nos do DeGóis e FCT|SIGcv, os sistemas de gestão curricular antecessores do CIÊNCIAVITAE. Deixa de ser possível importar os dados registados nestes sistemas mantendo-se disponível a sincronização com o ORCID e importação de dados das fontes RENATES (teses), PRIES (atividades docência e formação), RCAAP (publicações em repositório e SciPROJ (financiamento científico em Portugal). O Assistente de Importação encontra-se disponível no canto superior direito no editor do currículo.



Porquê o CIÊNCIAVITAE?

14 Setembro, 2021

CIÊNCIAVITAE | Serviço de Indicadores Institucionais



**Nov
2021!**

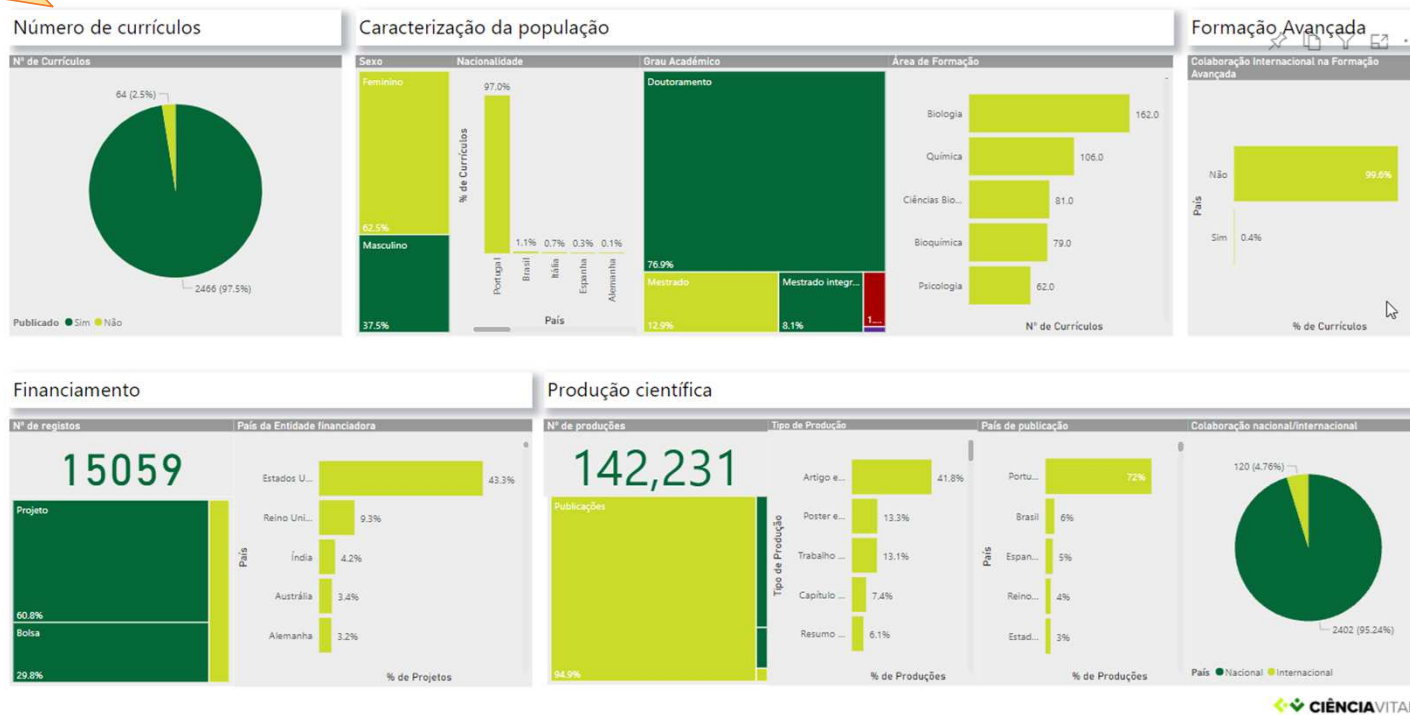

24
Instituições
beta-tester

36
Instituições
subscritoras

54%
Taxa resposta

CIÊNCIAVITAE | Serviço API



 **CRIA** HOME / RESEARCH / PUBLICATIONS

Publications

1-10 OF THE 5268 PUBLICATIONS

All Categories ▼

Data updated on 01-02-2021, from platform CIÊNCIAVITAE.

BOOK CHAPTER
State Power in the Relations between Catholics and Hindus
Fernandes, Jason. The Routledge handbook of Hindu-Christian relations. Routledge. New York

 O Centro ▼ **Investigação** ▼ Educação ▼ Transferência de Tecnologia ▼ Comunicação de Ciência ▼ Plataform

Início / **Investigação**

Publicações

Área de Investigação ▼ tipo de publicação ▼

Todas as Áreas de Investigação ▼ Todos os Tipos de Publicação ▼

Dados atualizados a 18-02-2021, a partir da plataforma CIÊNCIAVITAE.

Obrigada!

PTCRIS

Cátia Laranjeira

catia.laranjeira@fccn.pt



3415-1354-5489

0000-0003-3952-8294

20 de outubro de 2021

Patrocinadores Platina



Patrocinadores Ouro

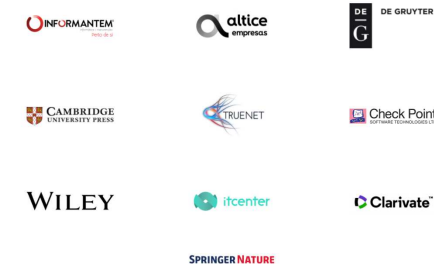

Patrocinadores Prata



Apoios



SERVIÇOS DE REPOSITÓRIOS DIGITAIS – DRD (RCAAP)

Paulo Lopes



[4317-2B5C-51C5](https://orcid.org/0000-0002-5550-3268)



[0000-0002-5550-3268](https://orcid.org/0000-0002-5550-3268)

20 de outubro de 2021

Patrocinadores Platina



Patrocinadores Ouro

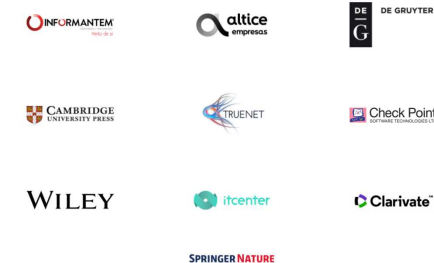

Patrocinadores Prata



Apoios



PROMOVER A CIÊNCIA ABERTA

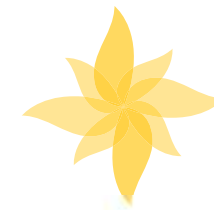

Disponibilização aberta de publicações, nomeadamente as que resultam de investigação com financiamento público



Ciência mais **eficiente, transparente, confiável e reprodutível**



Fonte: https://en.unesco.org/sites/default/files/open_science_brochure_en.pdf

jornadas.fcn.pt

ATIVIDADES SRD CIÊNCIA ABERTA

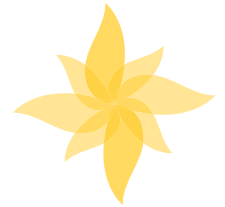

Repositórios
Científicos de
Acesso Aberto

Revistas
Científicas de
Acesso Aberto

Diretório de
Repositórios
Digitais

Missão SRD

Promoção da **Ciência Aberta**,
nas vertentes dos
**repositórios científicos de
acesso aberto e revistas
científicas de acesso
aberto.**

ATIVIDADES SRD

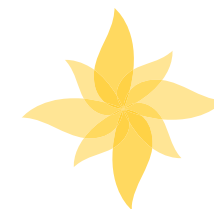

Repositórios Científicos de Acesso Aberto

- CORE RCAAP
- Integrações
- Serviços

Revistas Científicas de Acesso Aberto

- Plataforma Editorial
- SciELO Portugal
- Serviços

Diretório de Repositórios Digitais

- Governação
- Serviços

Serviços de Apoio ao Utilizador

Comunicação, Disseminação e Formação

Serviços Eletrónicos (infraestruturas e aplicações)

DESTAQUES

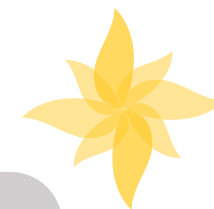

Repositórios Científicos de
Acesso Aberto

Revistas Científicas de
Acesso Aberto

Diretório de Repositórios
Digitais



 CIÊNCIAVITAE

PTCRIS – ECOSSISTEMA INTEGRADO

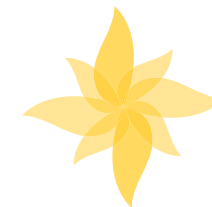

SoS = Sistema de Sistemas = ecossistema

STANDARDS E INFRAESTRUTURAS (PTCRIS)

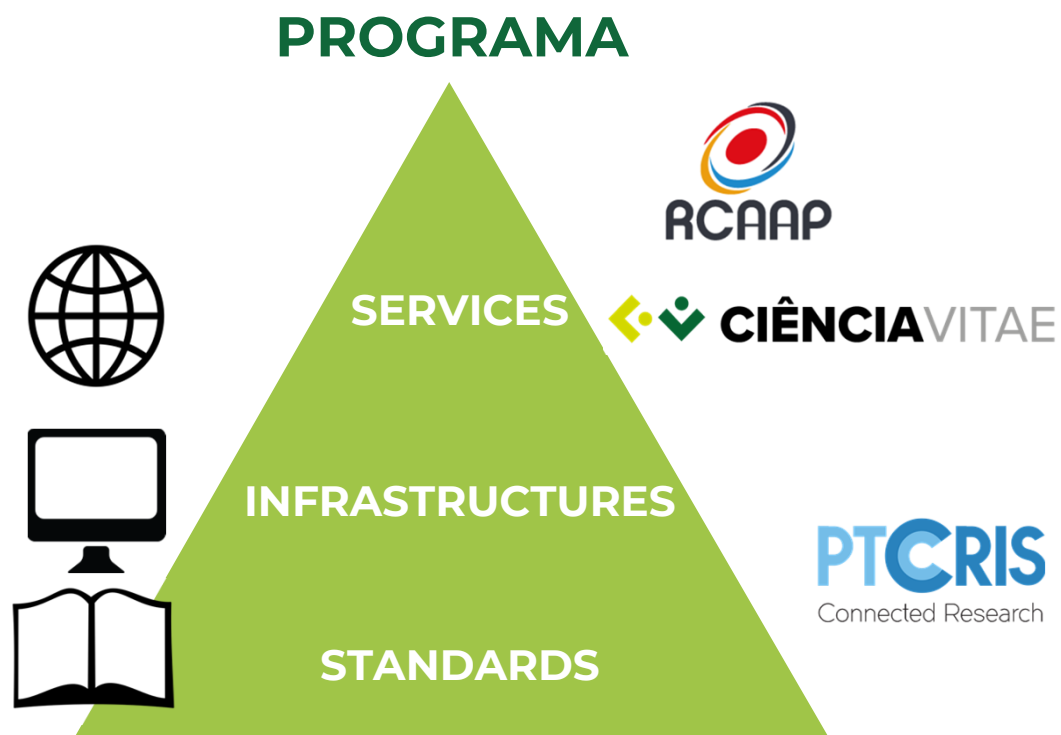
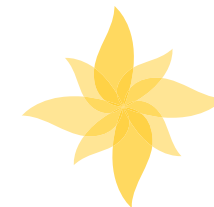

INTEROPERABILIDADE

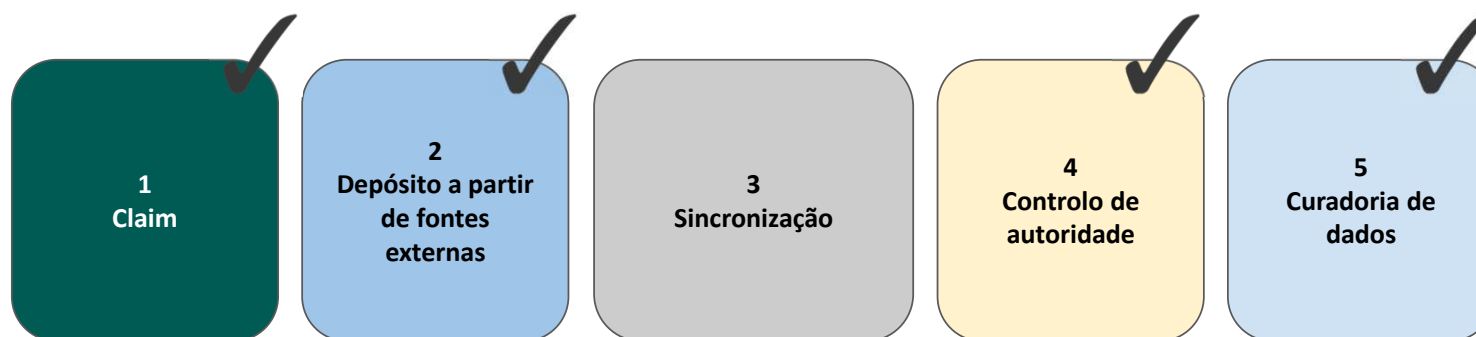
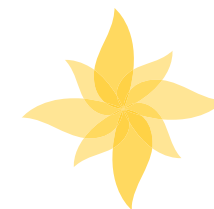



1
Claim

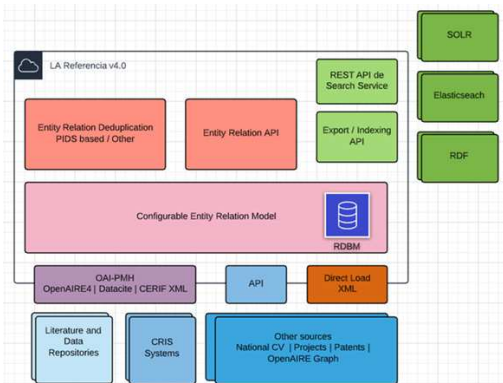

Novo modelo de dados
Nova API

DESTAQUES



Repositórios Científicos de
Acesso Aberto

Revistas Científicas de
Acesso Aberto

Diretório de Repositórios
Digitais



RCAAP theme

DSpace is the world leading open source repository platform that enables organisations to:

Pesquisar ...

 Pesquisar

DESTAQUES

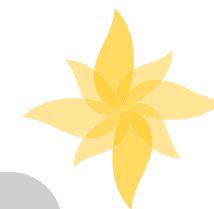

Repositórios Científicos de
Acesso Aberto

Revistas Científicas de
Acesso Aberto

Diretório de Repositórios
Digitais



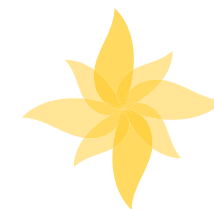

- Novos critérios de admissão e permanência alinhados com as práticas da Ciência Aberta;
- 23 novas revistas aceites no último ano;
- Upgrade da infraestrutura de suporte;
- Upgrade aplicacional;
- Marcação JATS_XML;
- Serviço DOI para revistas SciELO;
- Plano de formação / apoio.

DESTAQUES

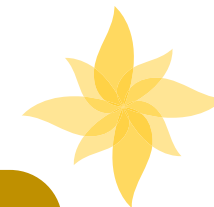

Repositórios Científicos de
Acesso Aberto

Revistas Científicas de
Acesso Aberto

Diretório de Repositórios
Digitais

index^R



index^R
Repositórios Digitais do Conhecimento

Pesquisa em Repositórios

[pesquisa avançada](#) 

Pesquisa

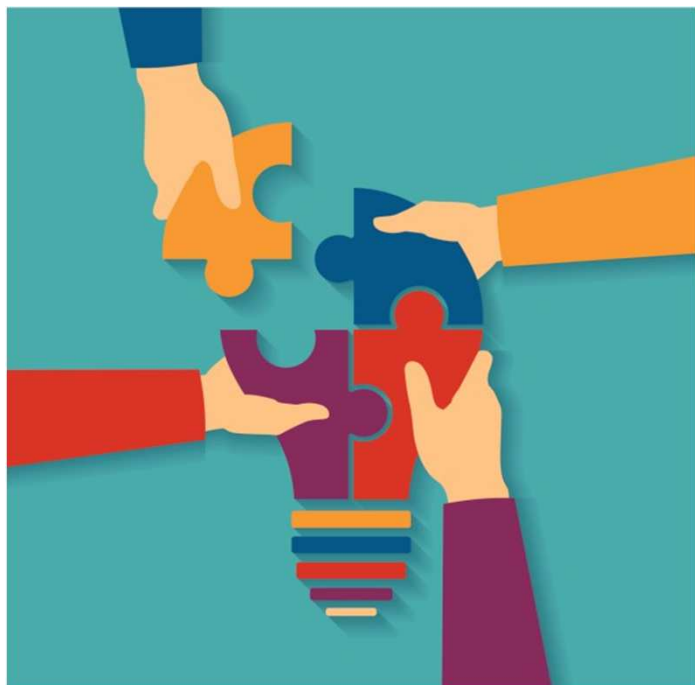
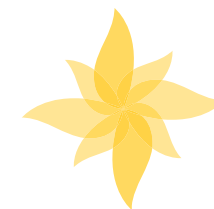

<https://medium.com/@MaanSaeed/knowledge-sharing-rather-than-knowledge-hoarding-8ac91269bcff>

SESSÃO “ARMAZENAR, PRESERVAR E PROMOVER O ACESSO AO CONHECIMENTO ABERTO EM PORTUGAL (RCAAP)”

DIA 20 DE OUTUBRO - 14H30

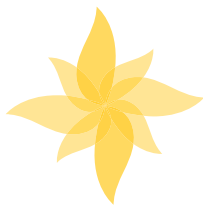

RCTS A HISTORY OF THE GLOBAL TRANSIT



Patrocinadores Platina



Patrocinadores Ouro

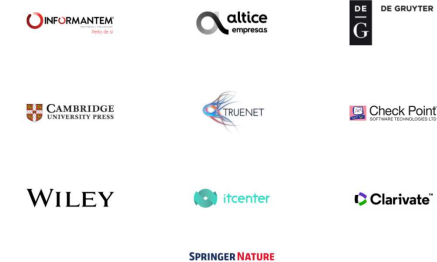

Patrocinadores Prata



Apoios



THE BEGINNING

Name	Network Speed	Nº of countries connected	Duration
PHARE	64kbps - 2Mbps	11 countries in Central and Eastern Europe (at May 1997)	1991 - 1997
EuropaNET	2 - 8Mbps	13 (at April 1997)	1992 - 1997
TEN-34	34Mbps	17 (at November 1998)	1997 - 1998
TEN-155	155 - 622Mbps	23 (at November 2001)	1998 - 2001

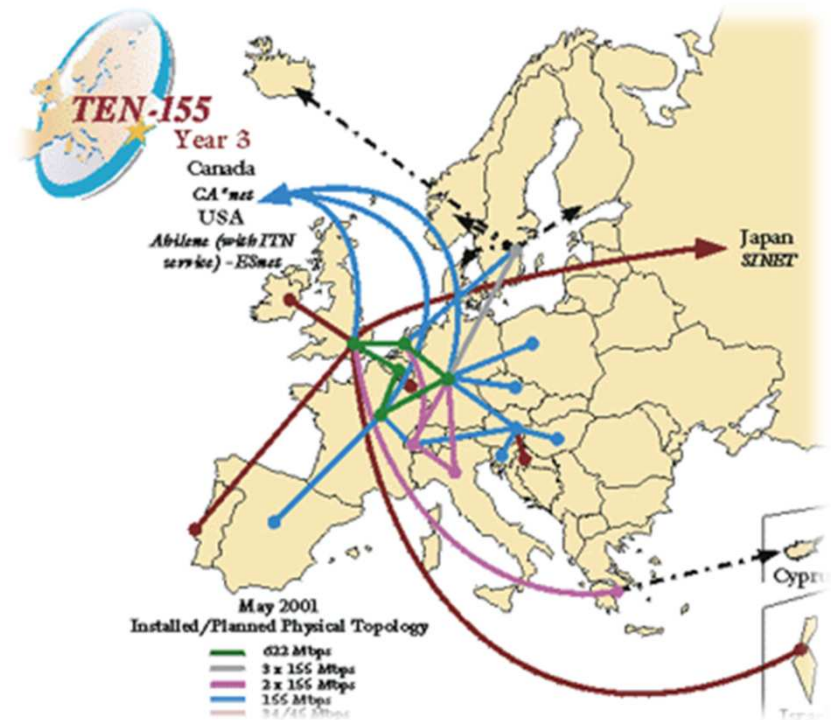

NATURAL EVOLUTION

Name	Network Speed	Nº of countries connected	Duration
GÉANT	2.5-10Gbps	33	2001 - 2005
GÉANT2	multi-gigabit	34	2005 - 2009
GÉANT3	100Gbps	40	2009 - 2013

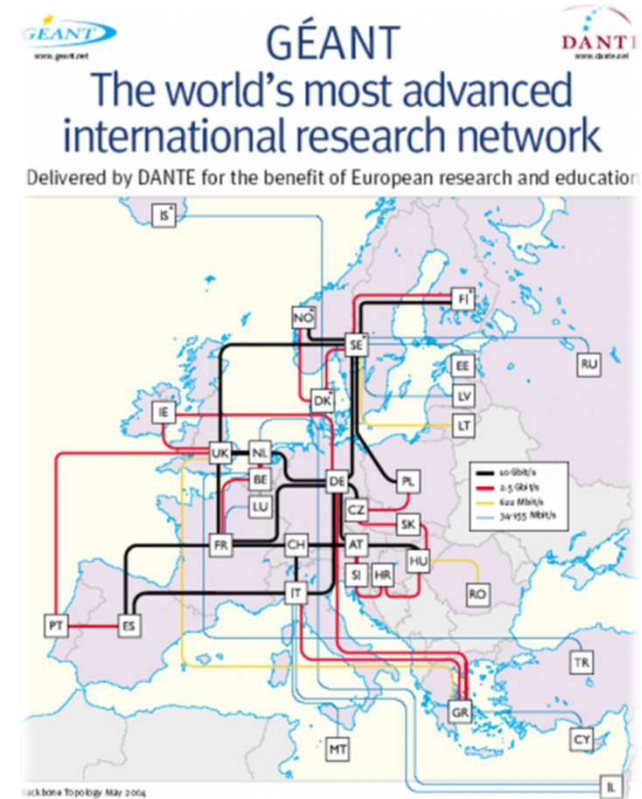

RCTS

2013:

- Migration of the backup link to GRID Datacenter
- First european Crossborder Fibre (CBF) activation between FCT|FCCN and Rediris

2015:

- 2nd CBF activation trough a diferente path

2019:

- 3rd CBF
- 4rd CBF
- Upgrade of the backup link to 30G
- Upgrade of the backup link to 40G

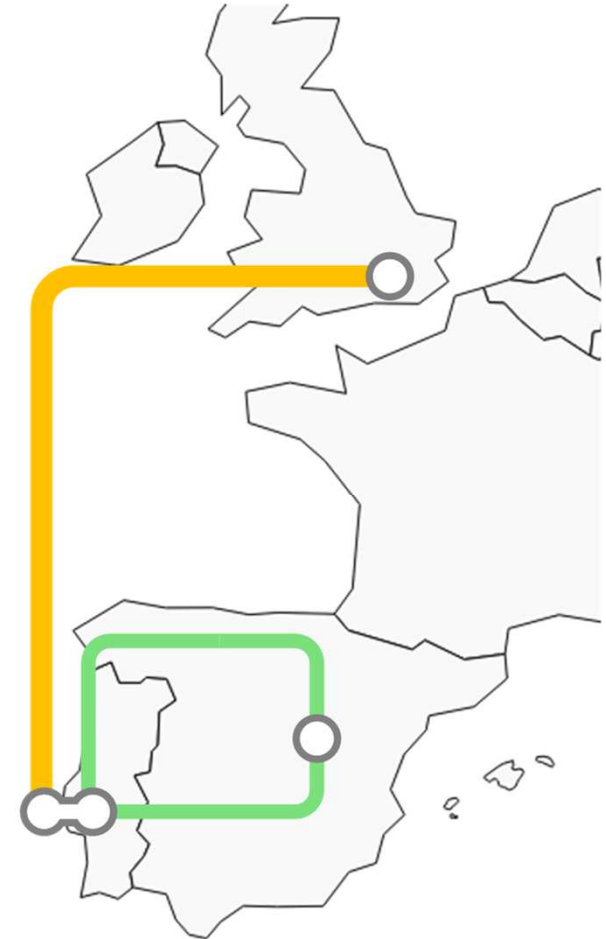

GN4-3N BASICS

Project

Network based on fibre optical links or spectrum, acquired in the form of Indefeasible Rights of Use (IRUs) to almost all the GÉANT NRENs

Use spectrum sharing (or full fibre) on existing NREN optical infrastructure wherever feasibly, economical and sustainable.

Duration

48 months - start Jan 2019, runs until end of 2022

14 countries connected on fiber

UK, BE, FR, CH, DE, AT, NL, HU, HR, IT, SI, SK, CZ, ES (spur)

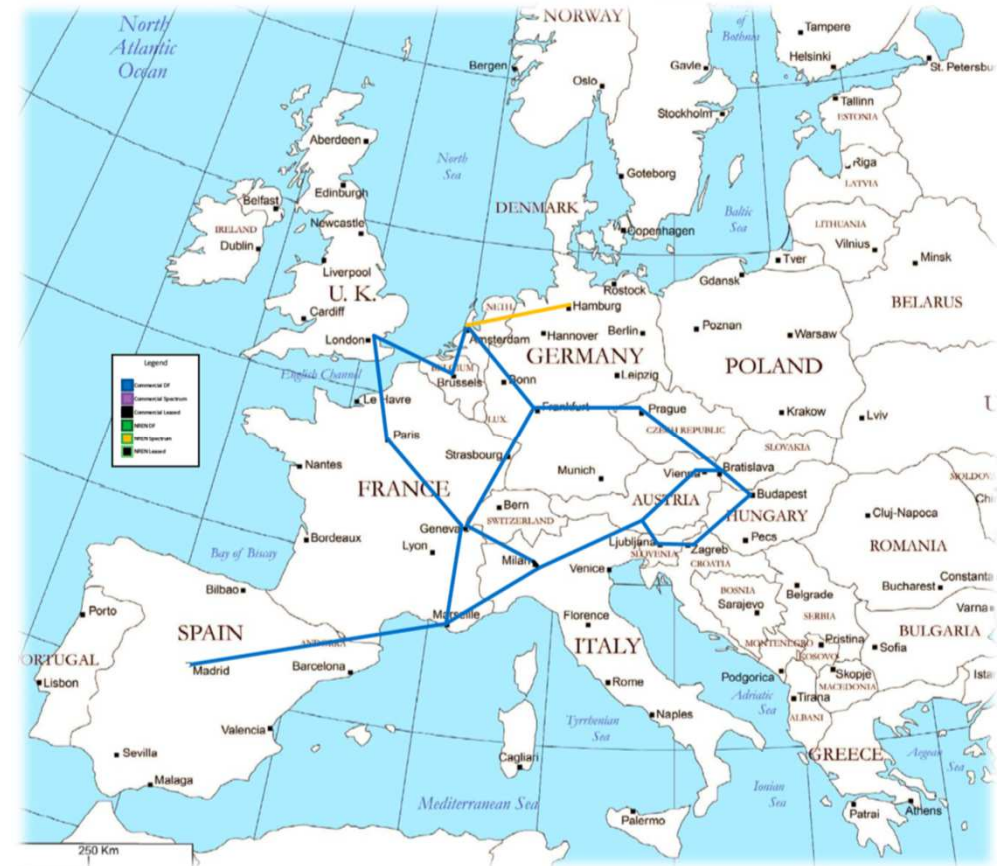

Starting Point – 2017 GEANT fibre network

GN4-3N STUDY

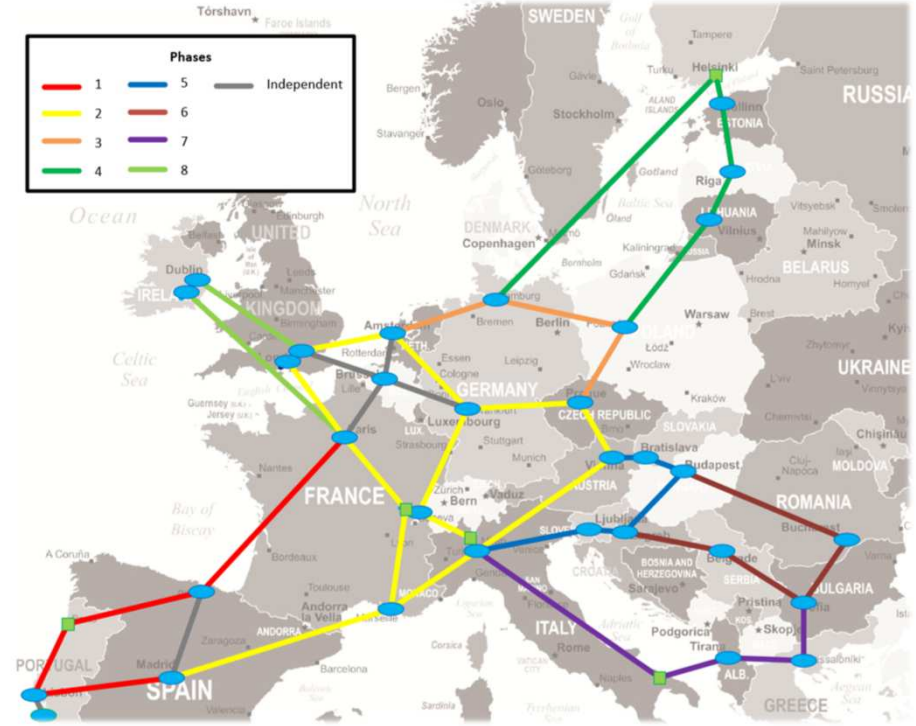

Study of the Iberian peninsula led by FCT| FCCN

Geant OTN in Portugal for the first time

Services delivered in Lisbon and Porto

GN4-3N STUDY

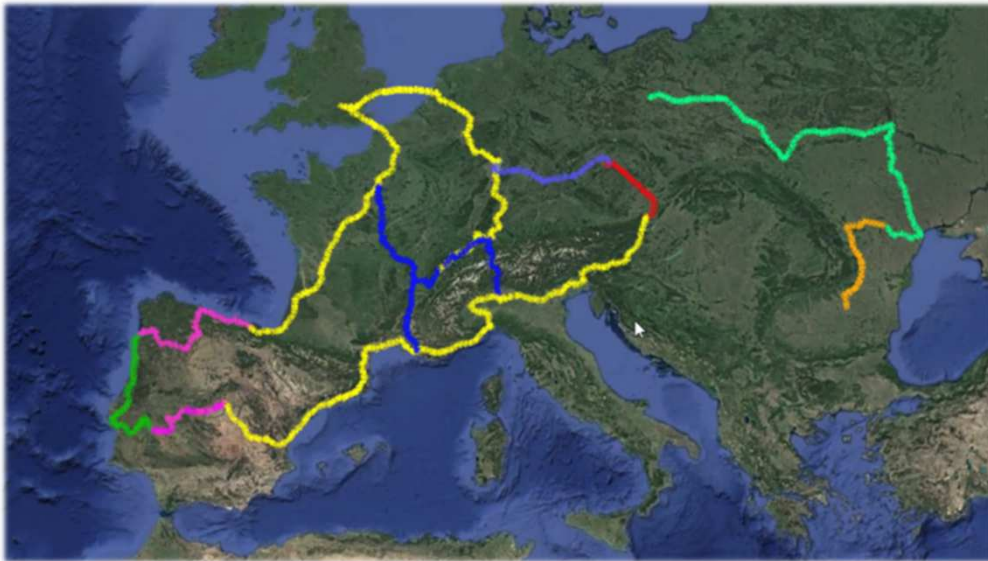

FCCN FIRST NREN TO MIGRATE TO NEW GÉANT FIBRE NETWORK



Paul Maurice



Share This!



FCCN is the first NREN to migrate from leased capacity to the new GÉANT fibre network as part of the €63.125m GÉANT (GN4-3N) project.

Representing the most significant refresh – and enlargement – of the pan-European GÉANT network in a decade, the GN4-3N project will see all GÉANT NRENs benefit from fibre or spectrum connectivity, helping to further narrow Europe's digital divide.

The Portuguese research and academic network managed by FCT's unit, FCCN, is now directly connected to GÉANT through Porto, ensuring a more resilient connection to the community.

Successfully migrating to its new Porto-Bilbao route (and in turn benefiting from the new Bilbao-Paris route), FCCN now enjoys improved performance, increased flexibility, and consistent and predictable long-term costs. With three routes (Lisbon-Porto, Lisbon-Madrid, Porto-Bilbao) on the new network, the benefits to FCCN's network infrastructure (RCTS – Rede Ciência, Tecnologia e Sociedade) – are expected to be significant.

RCTS LIVE

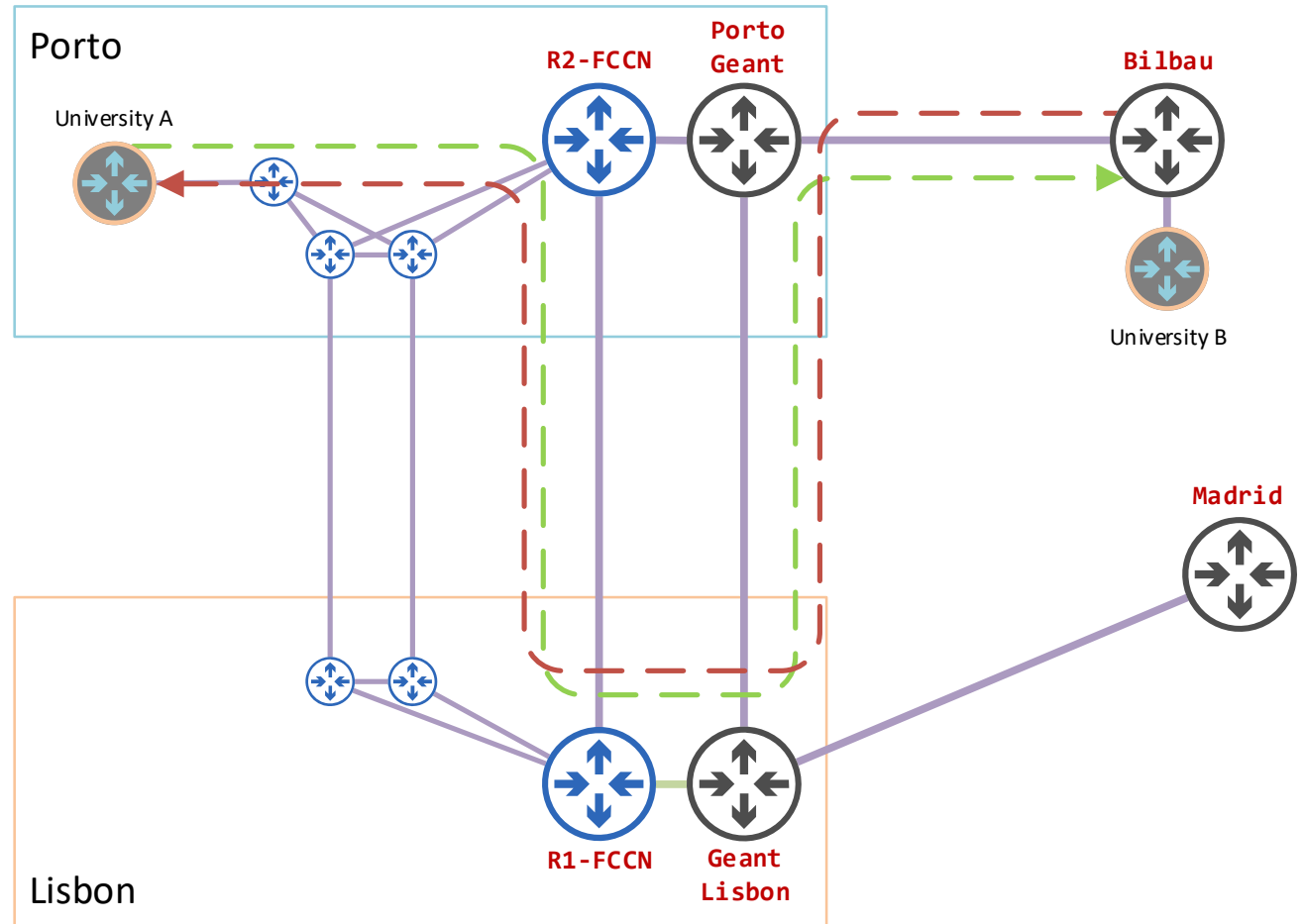

RCTS FUTURE ACTIVE/ACTIVE TOPOLOGY

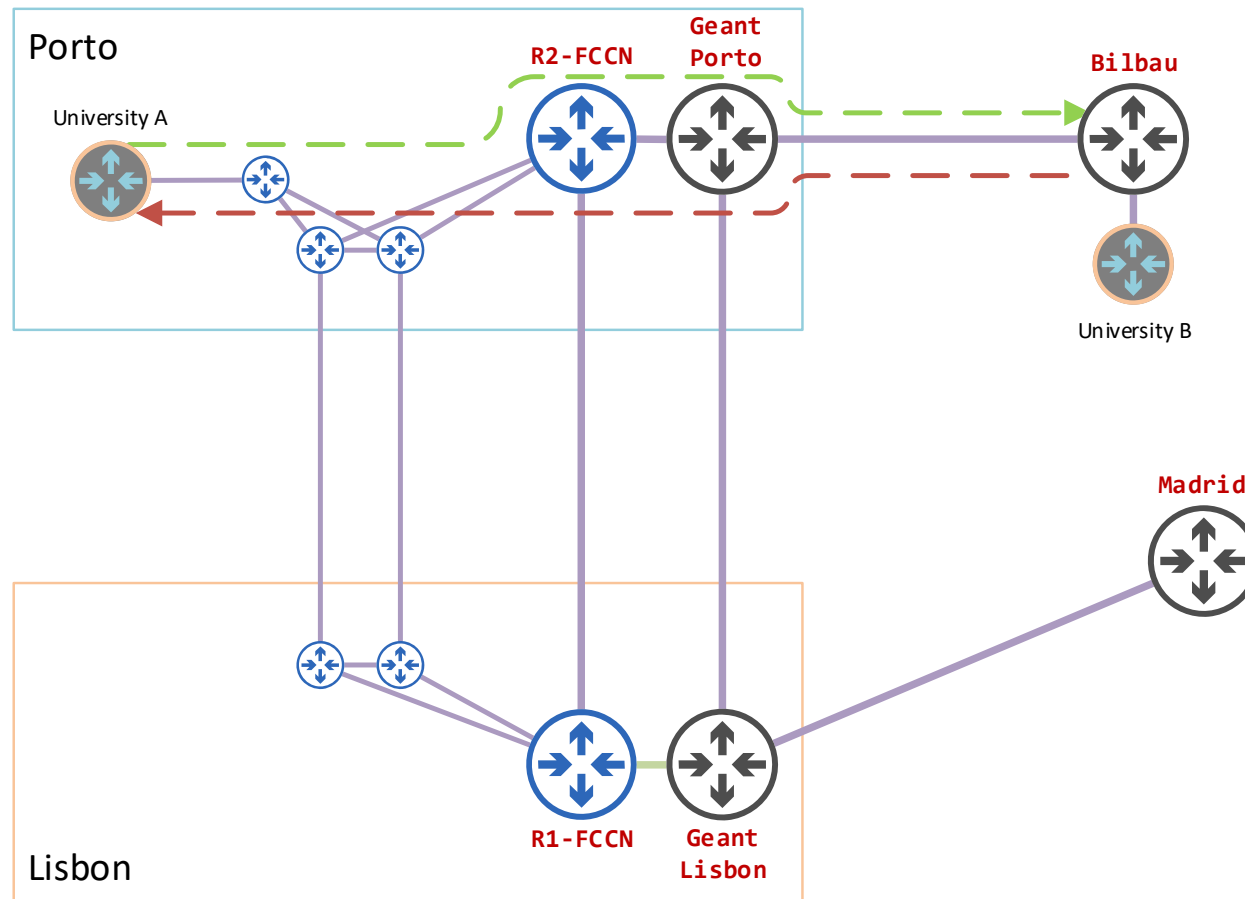

ACTIVE/ACTIVE TESTING



2021-09-15 08:00:00

Tráfego Out Others:	124 Mb/s
Tráfego Out Premium:	254 kb/s
Tráfego Out Peers Geant:	1.30 Mb/s
Tráfego Out Com:	3.55 Mb/s
Tráfego Out Acad:	546 Mb/s
Tráfego In Others:	521 Mb/s
Tráfego In Premium:	66.8 b/s
Tráfego In Peers Geant:	364 Mb/s
Tráfego In Com:	5.61 Mb/s
Tráfego In Acad:	468 kb/s

2021-09-15 08:00:00

Tráfego Out Others:	15.0 Mb/s
Tráfego Out Premium:	20.8 kb/s
Tráfego Out Peers Geant:	2.77 Mb/s
Tráfego Out Com:	1.69 Mb/s
Tráfego Out Acad:	641 Mb/s
Tráfego In Others:	14.4 kb/s
Tráfego In Premium:	1.97 kb/s
Tráfego In Peers Geant:	425 Mb/s
Tráfego In Com:	892 Mb/s
Tráfego In Acad:	430 Mb/s

Jornadas Computação Científica 2021



THANK YOU

Today – 14:30 – 16:00
RCTS - Novidades tecnológicas da rede académica
Portuguesa: Room DS01 - Block D

Patrocinadores Platina



Patrocinadores Ouro

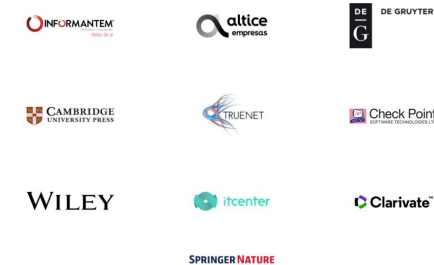

Patrocinadores Prata



Apoios



SERVIÇOS RCTS CERT

Carlos Friaças
2021/10/20



Patrocinadores Platina



Patrocinadores Ouro

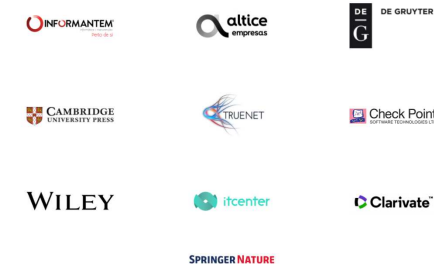

Patrocinadores Prata



Apoios



RCTS CERT

report@cert.rcts.pt

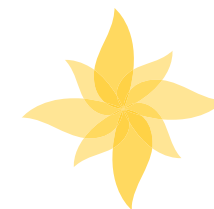

O que é?

Serviço de resposta a incidentes de segurança na RCTS.

A quem se destina?

Destina-se a qualquer pessoa que identifique um incidente de segurança informática com origem na RCTS.

A resolução dos incidentes pretende manter a **boa reputação** do endereçamento usado pelos membros da RCTS.



TRATAMENTO DE INCIDENTES

Cooperação com outras equipas

Salvaguarda da Confidencialidade

Análise de IOCs

Seguindo a Taxonomia da Rede Nacional CSIRT



AUDITORIAS

Principalmente websites

Produção de Relatório

Perdem a validade havendo alterações

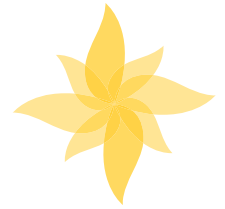

CAMPANHAS DE PHISHING

Avaliação e Sensibilização

Plataforma Open-Source GoPhish

Criação de um Storyline & Lançamento da Campanha

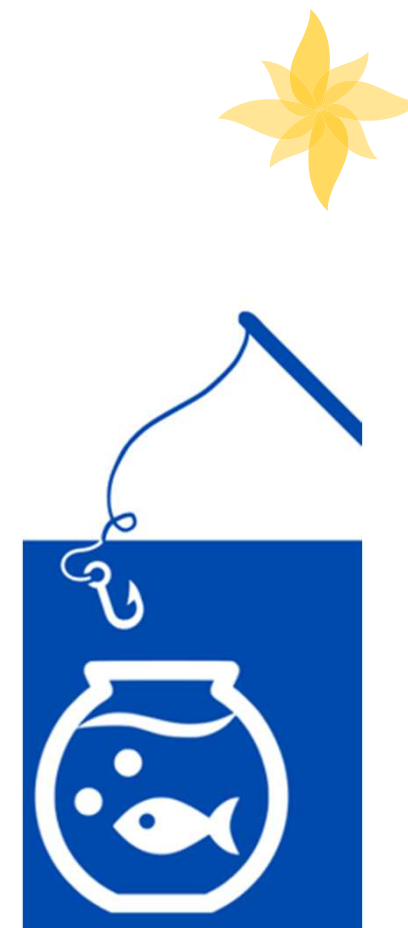

DNS FIREWALL

Impedir infecções que usem DNS para comunicar

Página com informação para reportar falsos positivos

> 20 instituições a usar

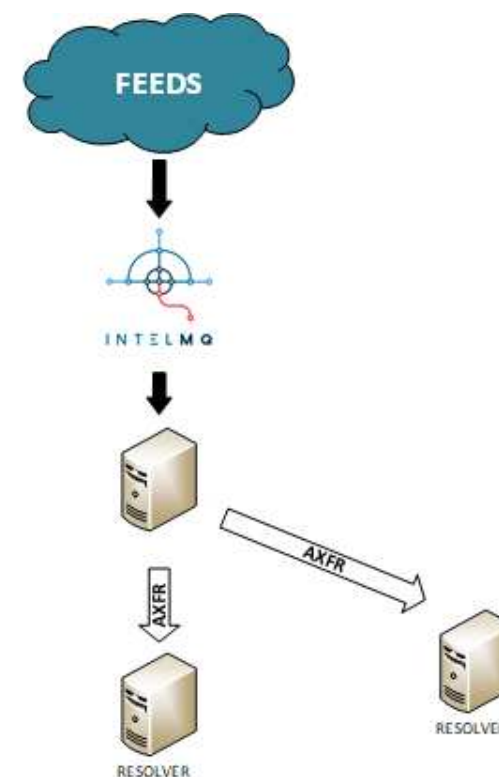
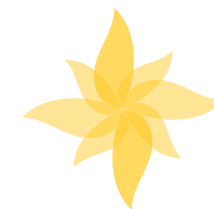

GESTÃO DE VULNERABILIDADES

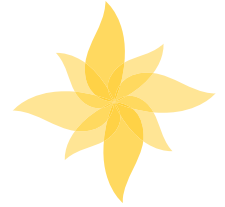

On-Demand vs. Agendado periodicamente

Ferramenta Nessus



Sugestões de mitigação

OBRIGADO!

report@cert.rcts.pt

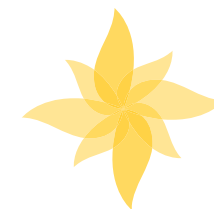

Sessão 21/Out

11:30 – 13:00

DS02

MetaRed

Capture The Flag

Decreto Lei 65/2021

UPDATE RCTS 100

Pedro Lorga
2021/10/20

Patrocinadores Platina



Patrocinadores Ouro

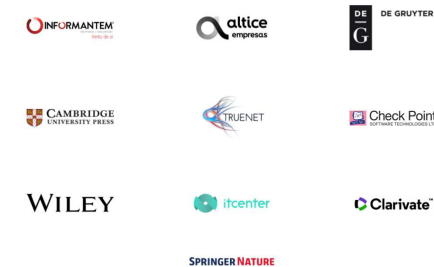

Patrocinadores Prata



Apoios



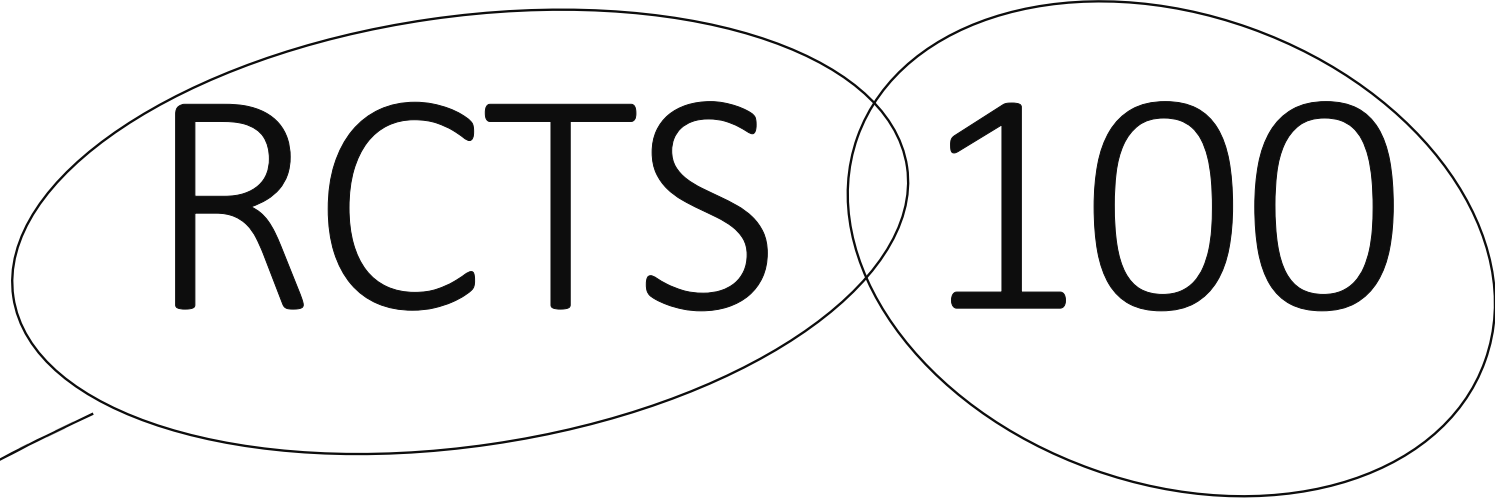

Rede Ciência Tecnologia e Sociedade
(Rede Nacional de Investigação e Ensino)

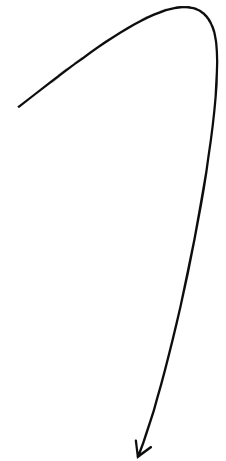

100 Gigabit por segundo
(ou mais...)

SERVIÇOS DE CONETIVIDADE

FIBRA ÓTICA

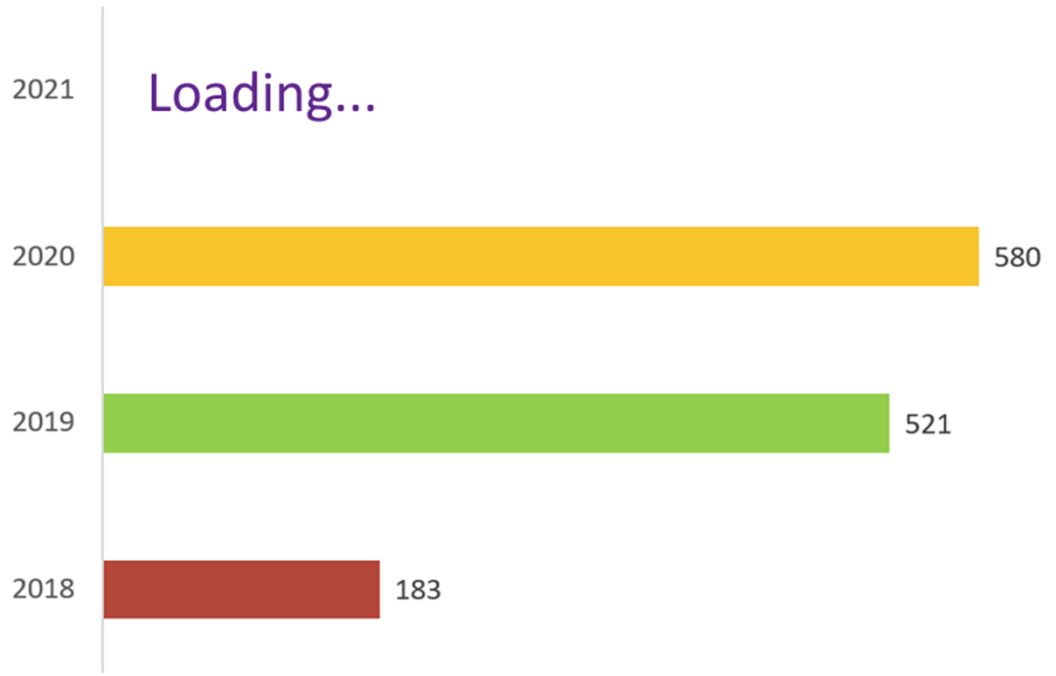

- 2018
- 2019
- 2020
- 2021

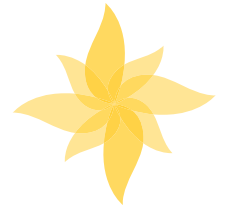
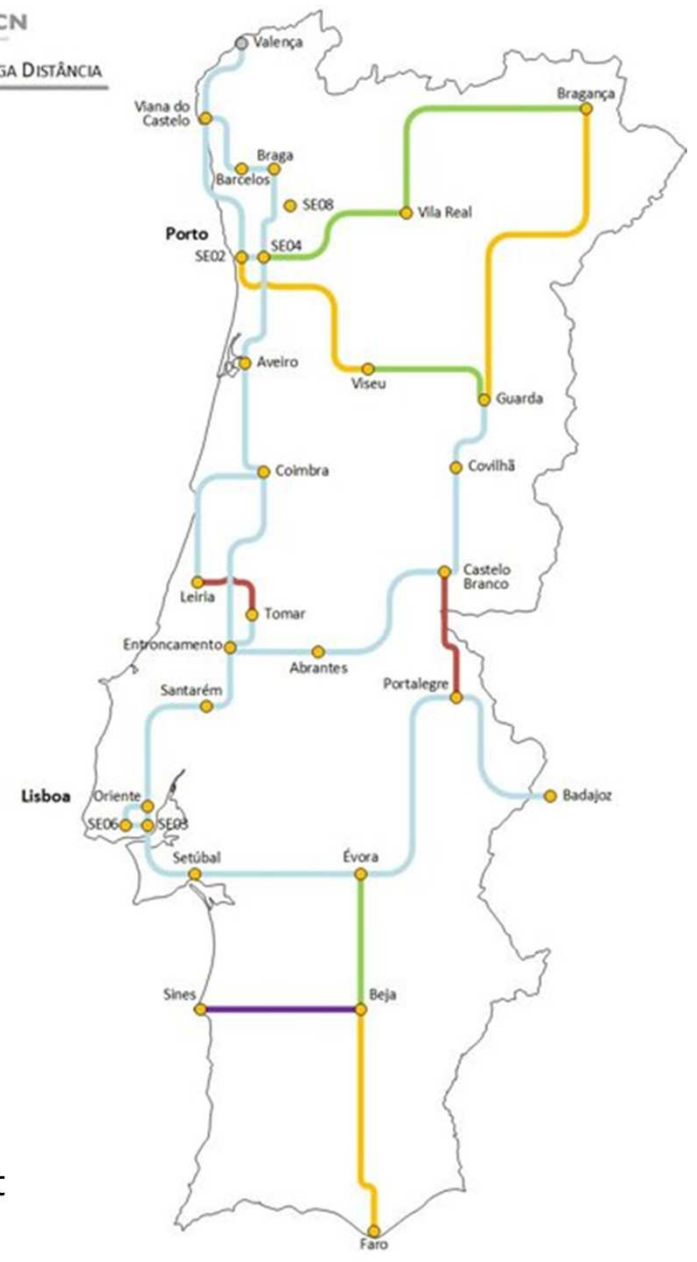

FIBRA ÓTICA

3324 Km de Fibra Ótica



1000 km

CABO DE FIBRA ÓTICA
(48 FIBRAS)

2324 km

(+1284)

PARES DE FIBRA ÓTICA

SISTEMA DWDM

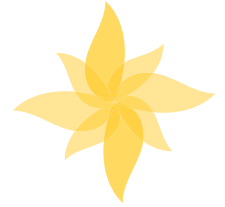

- DWDM com suporte de 96 canais de **200Gbps**
- Possibilidade de canais de **600Gbps** no futuro
- Primeiros lambdas de 200Gbps na RCTS



SISTEMA DWDM

50 Nós

36 OADM + 14 ILA

6,4 Tbps

CAPACIDADE INSTALADA DIA 1

AVANÇO TECNOLÓGICO

- SISTEMA COERENTE
- SUPER CHANNELS

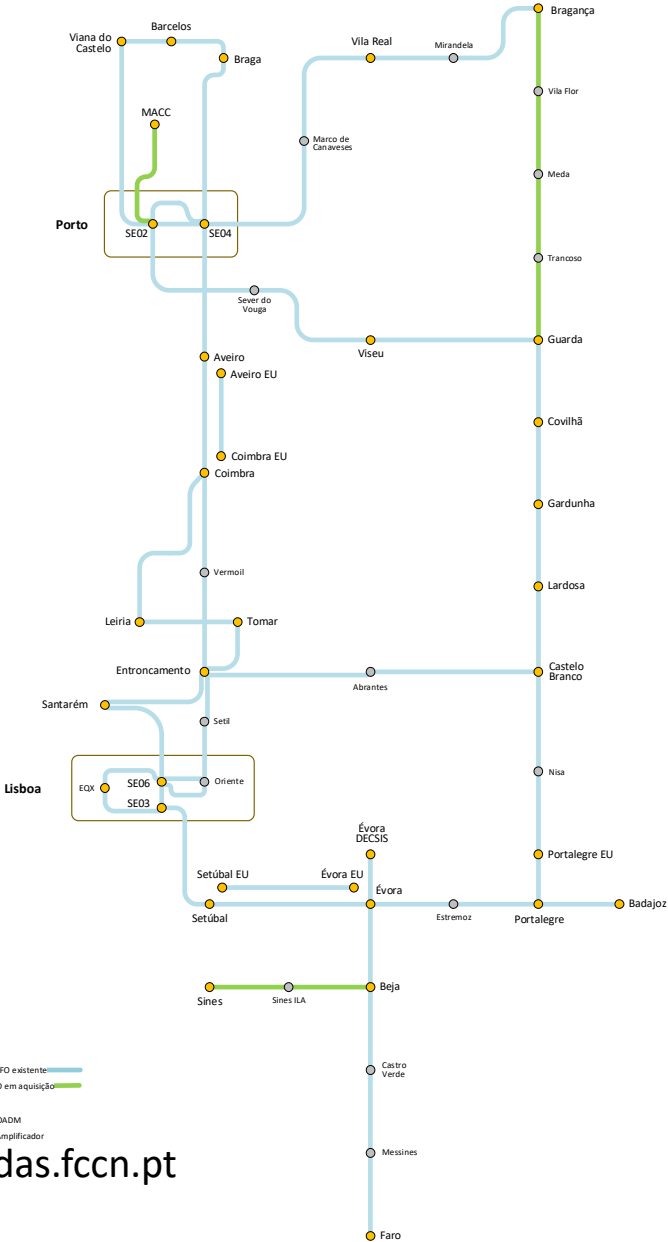
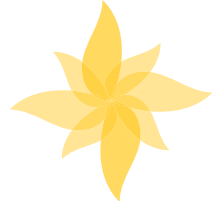

DISTRIBUIÇÃO IP

33

CPE ENTREGA SERVIÇOS
A 100GBPS

542

TRANSCEIVERS

AVANÇOS TECNOLÓGICOS

- MAIS LARGURA DE BANDA
- MELHORES TEMPO DE CONVERGÊNCIA
- MENOR LATÊNCIA
- MAIS REDUNDÂNCIA

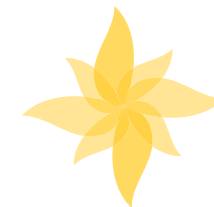
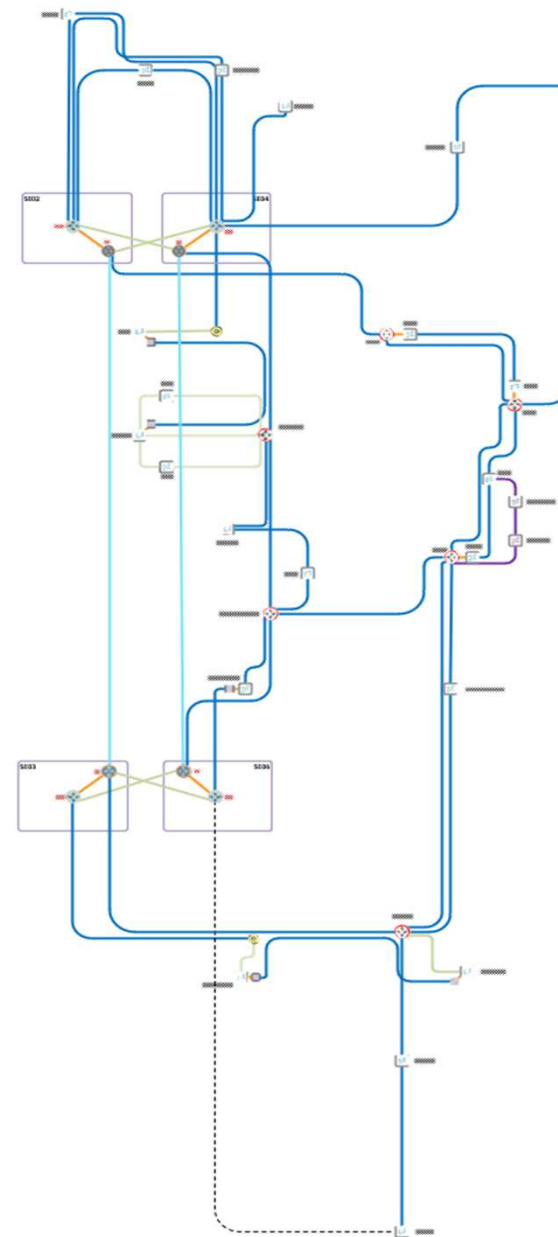

RCTS 200

20-10-2021 10H30

RCTS - NOVIDADES TECNOLÓGICAS DA REDE ACADÉMICA PORTUGUESA
SALA DS01

OBRIGADO!

Pedro Lorga
pedro.lorga@fccn.pt